



Owner's Operating Manual



VX-4c and VX-6c

*Digital Light Processing Projector
and VHD™ Ultra Controller*



THE WORLD'S FINEST HOME THEATER PRODUCTS™

TABLE OF CONTENTS

	Section	Contents	Page	
1	Introduction	1.1	The VX-4c/VX-6c Projector	1-1
		1.2	Anamorphic Lens	1-2
		1.3	Components	1-3
		1.4	Purchase Record and Servicing	1-3
2	Installation and Setup	2.1	Quick Setup	2-1
		2.2	Installing The Lens	2-2
		2.3	Installation Considerations	2-6
		2.4	Additional Considerations	2-6
		2.5	Throw Distances - Placement Section	2-7
		2.6	Vertical & Horizontal Position	2-9
		2.7	Mounting	2-11
		2.8	Folded Optics	2-12
		2.9	Source Connections	2-12
		2.10	RGB Signals	2-13
		2.11	Keypad Protocols and Conversions	2-14
		2.12	Converting a Keypad	2-17
		2.13	ISF Calibration	2-18
3	Operation	3.1	Overview	3-1
		3.2	Projector Basics	3-1
		3.3	Using the Keypad	3-3
		3.4	Navigating the Menus	3-9
		3.5	Using Inputs and Memory Banks	3-13
		3.6	Adjusting the Image	3-18
		3.7	Adjusting System Parameters and Advanced Controls	3-24
		3.8	Error Conditions	3-35
4	Maintenance	4.1	Warnings and Guidelines	4-1
		4.2	Cleaning	4-3
		4.3	Replacing Keypad Batteries	4-4
		4.4	Replacing the Lens	4-5
		4.5	Troubleshooting	4-8
5	Specifications	VX-4c / VX-6c Projector Specifications	5-1	

6

VHD Ultra Controller Manual	6-1
Warnings and Safety Precautions	6-2
Safety Tips	6-3
Introduction	6-4
General Description	6-4
Features and Benefits	6-4
Front and Rear Panel Descriptions	6-5
Front Panel Description	6-5
Rear Panel Description	6-6
Remote Control Description	6-8
Quick Set-up Guide	6-9
Connection Examples	6-9
Menu Description	6-10
Main Menu	6-10
Picture Quality Adjustments	6-11
Installation Menu	6-13
Screen Type	6-14
Image Shift	6-14
Blanking	6-15
System Reset	6-15
Aspect Ratios	6-16
Dimensions	6-18
RS-232 Communications	6-19
RS-232 Commands	6-20
VHD Ultra Specifications	6-22
A Glossary	A-1
B Keypad Reference	B-1
C Menu Tree	C-1
D Throw Distance	D-1

INTRODUCTION

1.1 The **VX-4c/VX-6c projector** is a professional quality DMD™ projector that uses Digital Light Processing™ (DLP™) technology from Texas Instruments to achieve high-brightness multimedia and video projection. The VX-4c/VX-6c is compatible with standard international video formats and can interface with IBM™-compatible PC, Macintosh™ computers and high-definition (DTV) decoders. The VX-4c/VX-6c is ideal for use in both large and small home theaters; performing exceptionally well in venues with ambient light.

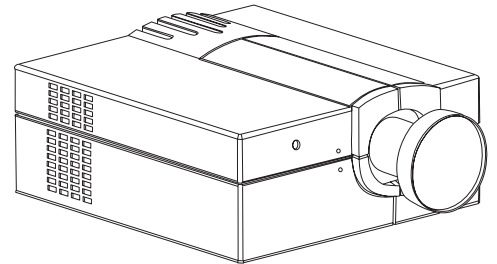

The features of the VX-4c/VX-6c include:

- ▶▶ The VHD Ultra Controller for optimum picture quality when using NTSC sources
- ▶▶ 1280 x 1024 native resolution, with other resolutions fully scaleable
- ▶▶ 3000 ANSI lumens light output (6000 ANSI VX-6c)
- ▶▶ Constant height aspect ratio control up to 2.35:1 screens
- ▶▶ Interchangeable lenses for screen widths up to 500 inches
- ▶▶ Memory for up to 99 custom “Memory Banks” (source setups)
- ▶▶ Intuitive on-screen menus or hidden direct control
- ▶▶ Modular design for easy servicing.

How The Projector Works?

The VX-4c/VX-6c can accept data/graphics and video input signals for projection on to front or rear flat screens. High brightness is generated by an internal 700W (1200W VX-6c) Xenon arc lamp, then modulated by three DMD (digital micromirror device) panels that provide digitized red, green or blue color information. Light from the “on” pixels of each panel is reflected, converged and then projected to the screen through a single front lens, where all pixels are perfectly superimposed as a sharp full-color image.

1.2 ANAMORPHIC LENS

DLP™ projectors use a small device called a DMD™ (Digital Micromirror Device) to create the video image. DMDs are designed in aspect ratios ranging from 4:3 (standard) and 16:9 (widescreen), to 5:4 (digital cinema). Understanding that more and more home theaters are designed using 16:9 or cinemascope projection screens (similar to your local Cineplex's), Runco has developed an anamorphic lens system to make the 5:4 DMD fully compatible with a home theater that has 16:9 and 2.35 screen formats.

The Runco Anamorphic Optical System elevates the image quality of a 16:9 picture to a higher level. This system consists of two components; one being the controller and the other the anamorphic lens. The first component is Runco's award-winning Vivix™ VHD™ Ultra Controller with 10-bit processing which is used to scale the video signal to match the native resolution of the projector. The second part utilizes one of three anamorphic lenses that optically stretch the image to a 16:9 or 2.35 aspect ratio.

The advantages of using the anamorphic lens system is that it takes advantage of the entire mirror array on the DMD™ resulting in a higher resolution picture. The result is a high-resolution picture in a big screen format for the home theater. Another benefit of employing all the mirrors on a DMD™ is 25% greater light output for an increase in picture brightness. Runco's industry-renowned controller helps to trigger the electronic corrections for the stretched image and provides four geometrically correct aspect ratios - 16:9 widescreen, letterbox, 4:3 and VirtualWide™. HDTV is also geometrically correct and has higher resolution. The Anamorphic optical systems include an Anamorphic lens, the lens mount assembly, and an Anamorphic Vivix™ Controller. The Anamorphic Optical System is the ultimate way to maximize resolution and will significantly shorten the throw distance of any Video XTreme™ series projector it is used with. Consult the specification sheet of the projector for specific throw distance calculations.

INTRODUCTION

1.3 Components

Included with the VX-4c/VX-6c is an infrared (IR) remote keypad, high-current 13 amp rated line cord, a 9/64" hex socket ball driver, and a VX-4c/VX-6c owner's manual. Make sure that you have all these items, and note that if you have purchased this projector, a purchaser's Warranty Registration Card is also included. Complete this card and return it directly to Runco International as soon as possible.

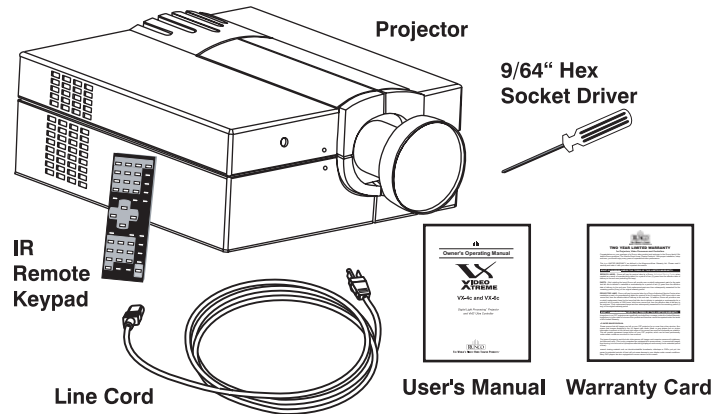

1.4 Purchase Record and Servicing

Whether the projector is under warranty or the warranty has expired, Runco's extensive factory and dealer service network is always available. Runco service technicians and dealers are fully trained to quickly diagnose and correct projector malfunctions.

Should you encounter a problem with the projector and require assistance, contact your Runco dealer or Runco International. In many cases, any necessary servicing can be performed on site. If you have purchased the projector, fill out the information below and keep with your records.

Purchase Record

Dealer:
Dealer Phone Number:
Projector Serial Number*:
Purchase Date:
Installation Date, if applicable:

**NOTE: The projector serial number is located on the projector's rear identification label*

INSTALLATION & SETUP

This section explains how to install and set up the projector. If you are familiar with the projector and want to quickly set it up for temporary use, follow the Quick Setup instructions below. For a more complete setup, follow the instructions and guides covered in the remaining subsections.

*NOTE: 1) The lens is not mounted when the projector is shipped from the factory. For instructions on how to install or replace a lens, refer to 4.4, **Replacing the Lens**.*

2.1 Quick Setup

Follow these steps for quick setup of the projector in a standard floor mount position.

STEP 1 ►► Position the Projector

Set the projector at the expected throw distance (projector-to-screen distance) and vertical position. Make sure that the projector is level from side-to-side.

STEP 2 ►► Connect a Source

Locate the main input panel at the rear of the projector. The lower left area, labeled **INPUT 1**, accepts an RGB input via BNC connectors. The upper right area (assuming a video decoder is installed) accepts a composite video at **INPUT 3** or S-video input at **INPUT 4**. Connect your source to the appropriate panel connectors.



STEP 3 ►► Connect the Line Cord to AC Power

Connect the projector's 13 amp high-current rated line cord to the AC receptacle at the lower right corner of the projector and to AC. Input power required is 100 - 240 VAC, 50 to 60 Hz @ 11.5 amps (@ 100 V). *Use only a high-current 13 amp rated cord.* See *Section 5*.



WARNING
DO NOT ATTEMPT OPERATION IF THE AC SUPPLY AND CORD ARE NOT WITHIN THE SPECIFIED VOLTAGE AND POWER RANGE.

STEP 4 ►► Turn the Projector ON

Using either the built-in or remote keypad, press  and hold for approximately 1 second to turn the projector on (or press  ). Let the projector warm up for about five minutes. The **POWER LED**, located in the lower right corner of the rear input panel, should glow a steady green.

INSTALLATION AND SETUP

2.2 Installing The Lens

A variety of lenses are available to accommodate different throw distances and specific types of installations. See page 2-10 for details. To change/install a lens, follow the steps below.

*NOTES: 1) You will need a 9/64" (3mm or 3.5mm) hex socket ball driver (supplied with projector) or allen wrench for this procedure. 2) "Top" or "bottom" references assume a non-inverted projector, as illustrated. 3) If you are installing a lens, first make sure its **Lens Adapter** is present on either the lens or projector. Such an adapter/flange secures to the projector in the same manner as the flange described below, but accommodates a screw-mount lens.*

STEP 1 ►► Turn off the projector, cool, and unplug.

Before removing or installing a lens, turn off the projector and allow it to cool for five minutes before unplugging. Make sure that the lens cap is on.

⚠ WARNING
Unplug the projector.
Install the lens cap.

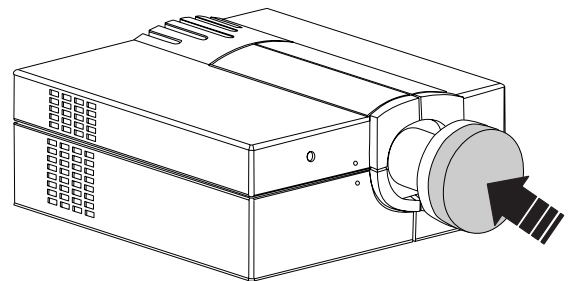

Install Lens Cap

STEP 2 ►► Loosen the 3 lens mount screws

● **IF FIXED LENS:** Use the hex socket ball driver provided with the projector to loosen the 3 lens mount screws that secure the lens flange to the mount-loosen these screws only, do not remove.

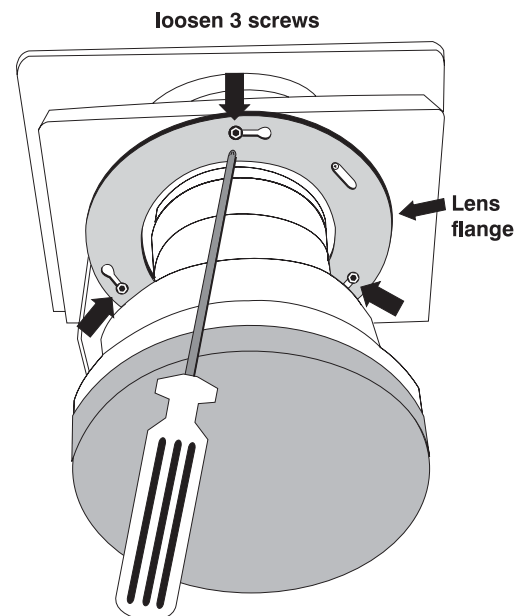

**Loosen 3 screws
- FIXED LENS -**

INSTALLATION AND SETUP

- **IF ZOOM LENS:** Access to the 3 lens mount screws is likely blocked by the toothed zoom ring in front of it. First rotate the zoom ring by hand until its 3 access holes align with the screws, then insert the hex socket ball driver through the holes to loosen the screws-do not remove. See figure to the right.

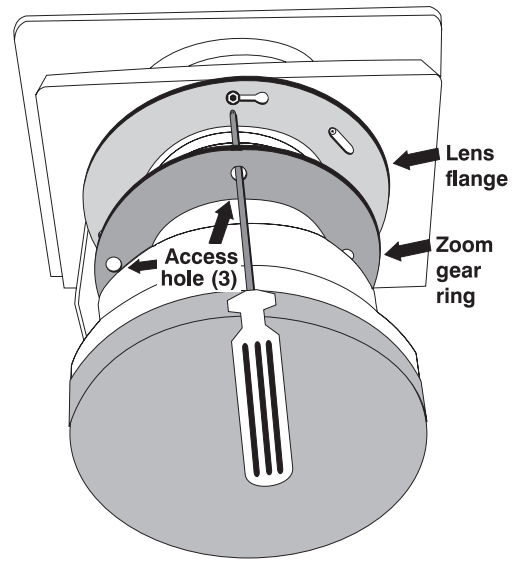

**Align zoom gear ring to access 3 screws
-ZOOM LENS-**

STEP 3 ▶▶ Rotate the lens barrel slightly

- Using both hands, rotate the lens barrel counter-clockwise until the screw heads align with the larger end of their slots on the lens.

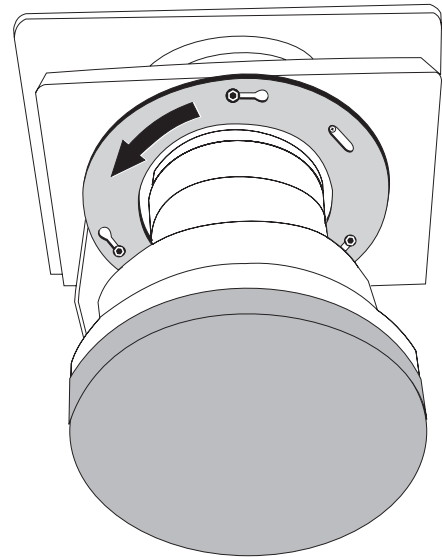

Rotate Slightly

INSTALLATION AND SETUP

STEP 4 ▶▶ Pull lens assembly out

- Carefully pull the lens assembly straight out of the projector and set aside.

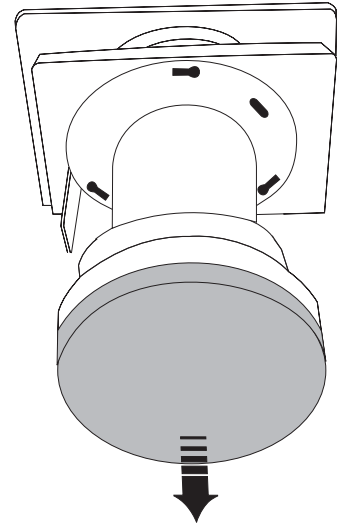

Remove Lens Assembly

STEP 5 ▶▶ Install new lens assembly

- **IMPORTANT:** Remove the rear (smallest) lens cap from the new lens. Make sure the **front** lens cap remains on during installation.

- Align the large cut-out area on the lens flange to the **bottom** of the lens mount (which has a matching cut-out). The 3 lens assembly slots should align with the lens mount screws so that the screw heads will fit through the large end of the slots (see Orientation figure).

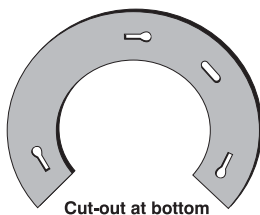
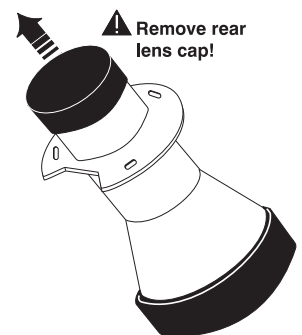

Cut-out at bottom

Orientation

NOTE: On most lenses, a small extra “keying” slot located at approximately 2 o’clock on the lens flange will align with a set screw in the same location on the lens mount, preventing the lens from being installed in the wrong orientation. If the lens flange does not seem to fit into place over all screws, try rotating the lens assembly in one direction or another.

- With the lens assembly aligned and the screws inserted through the flange, use both hands to rotate the lens barrel clockwise until the lens mount screw heads lock into the small end of the lens assembly slots.
- Secure the 3 lens mount screws.

STEP 6 ▶▶ Reposition the projector for new lens

Remove the front lens cap and reposition the projector closer or further from the screen as necessary for the screen and the new lens type (refer to Throw Distance section 2.6). In a permanent installation, always use the appropriate throw distance formula to calculate the distance accurately. Power up and test. Adjust offsets as necessary.

INSTALLATION AND SETUP

STEP 6▶▶ Adjust Image

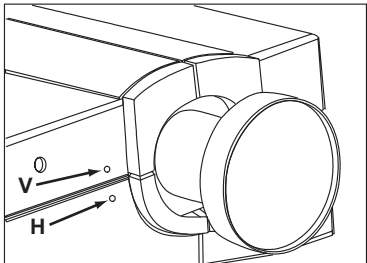
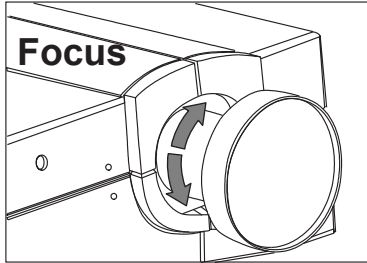
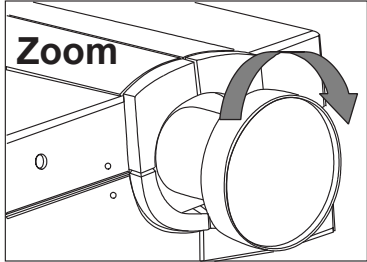

● **ZOOM:** With the input image displayed, rotate the textured ring on the lens barrel to increase or decrease the image size (this requires a zoom lens). If you do not have a zoom lens or you can not adjust the image enough, the projector may not be positioned at the proper throw distance for your screen size. Power down, unplug the projector and move it towards or away from the screen.

● **FOCUS:** At the lens opening, turn the focus tab to focus the image clearly.

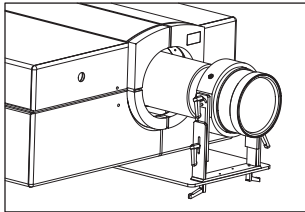

1.33
Anamorphic Lens

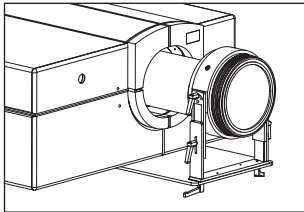

1.42
Anamorphic Lens

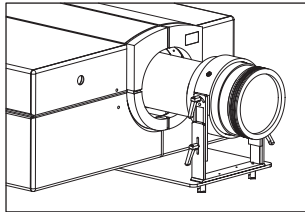

1.90
Anamorphic Lens

960P 16x9

1024P 16x9

1024P 2.35:1

● **OFFSETS:** Turn either or both of the adjustment screws (with the provided hex driver) adjacent to the lens if you need to align the image with your screen-turn the top screw to raise or lower the image. Turn the bottom screw to shift the image left or right. Re-check focus.

● **OTHER:** Press **Menu** to refine other display parameters as described in *Section 3.3 Using the Keypad*.

Adjust Image (Motorized Models)

NOTE: Only for units equipped with motorized lens control.

With the input image displayed, press **Lens** on any keypad.

Scroll menu with **▲ON** and **▼OFF**

Lens Control		
Focus	3140	
Zoom	5711	
Lens Horizontal Offset	4881	
Lens Vertical Offset	2664	
Intelligent Lens System	<input type="checkbox"/>	
Calibrate Lens		
Center Lens		

Adjust with **←-** and **→+**

= No offsets (approx.)

If you've just installed the lens, select "Calibrate Lens" before making any adjustments (See section 3 for details). Then, with the Lens Control menu displayed, use the keypad as shown to the left, *Motorized Lens Adjustment*, to focus the image clearly and, if a zoom lens is present, to increase or decrease image size. If desired, adjust horizontal and/or vertical offsets to shift the lens and image location - ranges are shown in 2.7 *Vertical and Horizontal Position*.

Motorized Lens Adjustments

INSTALLATION AND SETUP

Press  to refine other display parameters, if necessary. See 3.5 *Using Inputs and Memory Banks* if you want to work with other source inputs or defined memory banks.

You may want to reduce initial setup time by starting with an “Auto Setup”. The projector will automatically optimize a variety of display settings according to the incoming source detected. You can then re-adjust these settings at any time, if desired.

2.3 Installation Considerations

Although this projector delivers a high brightness quality output, final display quality could be compromised if the projector is not properly installed. This subsection discusses issues you should consider before proceeding with a final installation. Even if you do not intend to use the projectors in a fixed and permanent installation, this subsection will help you to better understand what you can do to enhance display performance.

Lifting

For any new installation, you will likely have to safely lift the projector into place. Keep in mind that the projector is quite heavy, and the aid of a CO₂ or other type of mechanical lift is highly recommended.

2.4 Additional Considerations

Here are some other considerations and tips which can help you improve your installation:



Ventilation is an important factor when preparing a projection room. The ambient temperature should be kept constant and below 35°C (95°F). Keep the projector away from heating and/or air conditioning vents. Changes in temperature can cause drifts in the projector circuitry that may affect performance.



- Keep the projector away from devices that radiate electromagnetic energy such as motors and transformers. Common sources of these are slide projectors, speakers, power amplifiers, elevators, etc.
- For rear screen applications, less space is required if a mirror is used to fold the optical path.
- Choose the right screen size for the application:
 - △ As screen size increases, magnification increases and reduces brightness. Select a screen size which is appropriate for the theater, but not larger than what is required.
 - △ Installing a large screen in a small room is similar to watching television close up; too large a screen can overpower a room. A good rule of thumb is to be no closer than 1.5 times the width of the screen.
 - △ Larger screens require greater attention to lighting conditions.

INSTALLATION AND SETUP

2.5 Throw Distances - Placement Section

Projector VX-4c/VX-6c	Throw Distance	Optical Resolution	Screen Aspect Ratio
720p	Lens 1: 0.8 Lens 2: 2.2 - 4.0 Lens 3: 4.0 - 7.0	720p	1.78:1 or 1.33:1
960p	Lens 1: 1.65 - 3.0 Lens 2: 3.0 - 5.25	960p	1.78:1
1024p	Lens 1: 1.55 - 2.80 Lens 2: 2.80 - 4.90	1024p	1.78:1
1024p w/ 2.35 aspect ratio	Lens 1: 1.15 - 2.10 Lens 2: 2.10 - 3.65	1024p w/ 2.35 aspect ratio	2.35:1

The **VX-4c/VX-6c 720P** system offers high definition resolution in a 16:9 format, while providing multiple aspect ratio selection. Without the use of an anamorphic system.

The **VX-4c/VX-6c 960P** system provides a 26% increase in brightness and resolution over the base 720P configuration. (Using a 1.33 x Anamorphic lens)

The **VX-4c/VX-6c 1024P** system yields digital cinema resolution by employing every available pixel for a maximum picture clarity and brightness. (Using a 1.42 x Anamorphic lens)

The **VX-4c/VX-6c 1024P/2.35:1** system also makes the maximum resolution fully available, on a 2.35:1 aspect ratio screen. All other common aspect ratios are selectable using the constant height approach. This system was created for the true cinemaphile owning a theater with a cinemascope screen. (Using a 1.90 x Anamorphic lens)

INSTALLATION AND SETUP

Always consult this section when planning a projector installation. See also section 2.7 and 2.8, Projector Position and Mounting.

Calculating Throw Distance

Correct throw distance depends on the screen size and lens present—the larger the image needed, the greater the distance you must allow between the lens and screen. Once you know the screen size and lens type present, you can calculate the precise throw distance you require by using the appropriate formula as found in this appendix.

Throw distance is the distance between the projector front feet and the screen. This measurement is not necessarily parallel to the floor—i.e., the projector and screen may be inclined.

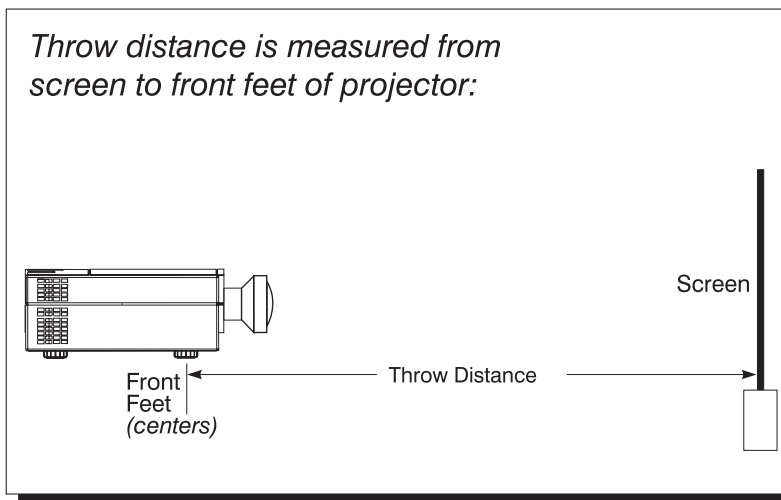

NOTE: If your projector is tilted up or down in relation to the screen, as is sometimes the case for large venues or elevated installations, throw distance still represents the smallest measurement between the screen and front feet centers.

Pre-calculated throw distances for the complete range of lens types and screen sizes appear in the charts and graphs on the following pages. Refer to these examples to quickly determine the proper throw distance ($\pm 5\%$) for your installation and lens.

NOTE: Variable operating ranges for zoom lenses appear in graphs only.

2.6 Vertical & Horizontal Position

THE VERTICAL POSITION of the projector in relation to the screen also depends on the size of the screen and the lens type. Correct vertical position helps ensure that the image will be rectangular in shape rather than keystone (having non-parallel sides) and that image focus and brightness both remain optimized.

In addition, vertical position of the image can be manually offset—that is, moved up or down—by turning the top screw on the front of the projector (the bottom screw if the projector is ceiling mounted). The range of adjustment is roughly 130%, depending on the specific lens you are using and whether or not you are also offsetting horizontally. See Table 1 for the percentage of the image that can be displayed above and below the center of each type of lens designed for this projector. These image offsets are also illustrated below (Fixed Lenses) and on the following page (Zoom Lenses).

Table 1. Maximum % of Image Offset from Lens Center

<i>Lens Type</i>	<i>Max. Recommended Image Offset</i>	
0.8:1	↑ 105%	↓ 100%
1.5 - 2.2:1	↑ 129%	↓ 117%
2.2 - 4:1	↑ 129%	↓ 117%
4 - 7:1	↑ 137%	↓ 126%

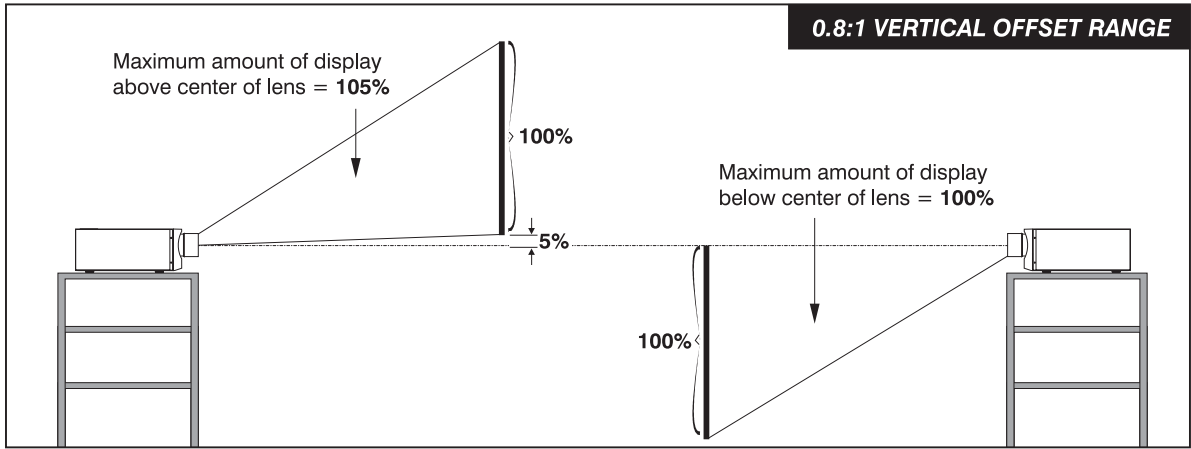

Maximum Vertical Offsets (FIXED LENSES)

INSTALLATION AND SETUP

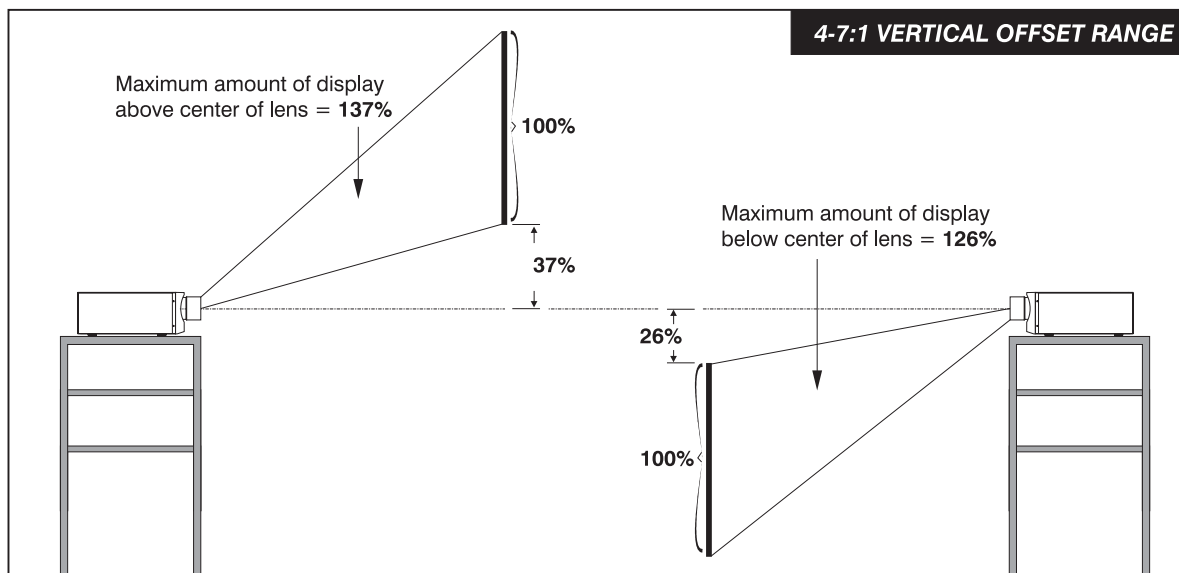
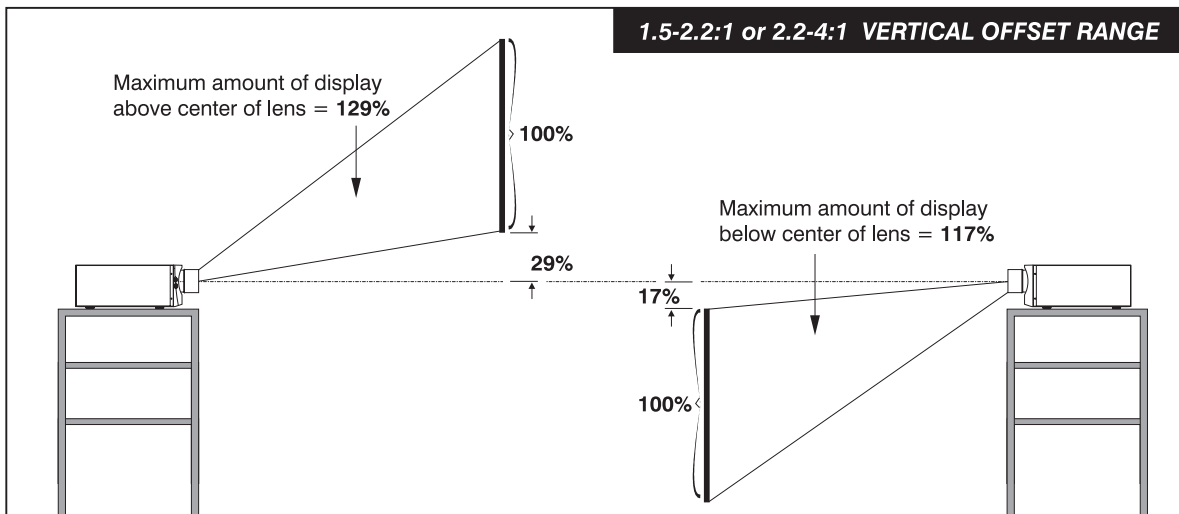

Maximum Vertical Offsets (ZOOM LENSES)

NOTES: **1)** If you cannot raise or lower the image enough using mechanical vertical offsets, try adjusting *V-Shift* in the **Scaling Parameters** menu (see 3.6, **Adjusting the Image**). **2)** If the image becomes keystoneed or exhibits uneven brightness, the projector may simply be too high or low in relation to the screen. **3)** Recommended offset ranges can be exceeded, however this may affect image quality. **4)** Simultaneous horizontal and vertical offset limits the adjustment range of each.

NOTES FOR ALL LENSES:

Maximum optical performance is produced at zero offset (i.e., with the projector at the center of the screen) — geometry, focus and light output will all be optimized.

Offset ranges are reduced when offsetting in both horizontal and vertical directions simultaneously.

For inverted projectors, invert the Vertical Offset illustrations.

THE HORIZONTAL POSITION of the image can be offset—that is, shifted left or right of lens center—by turning the bottom screw on the front of the projector (the top screw if the projector is ceiling mounted). The maximum horizontal offsets for the lenses designed for this projector is shown on the following page. For this projector, this value expresses the maximum percentage of the image that can be projected to one side of the lens center (roughly 80%, depending on the lens).

INSTALLATION AND SETUP

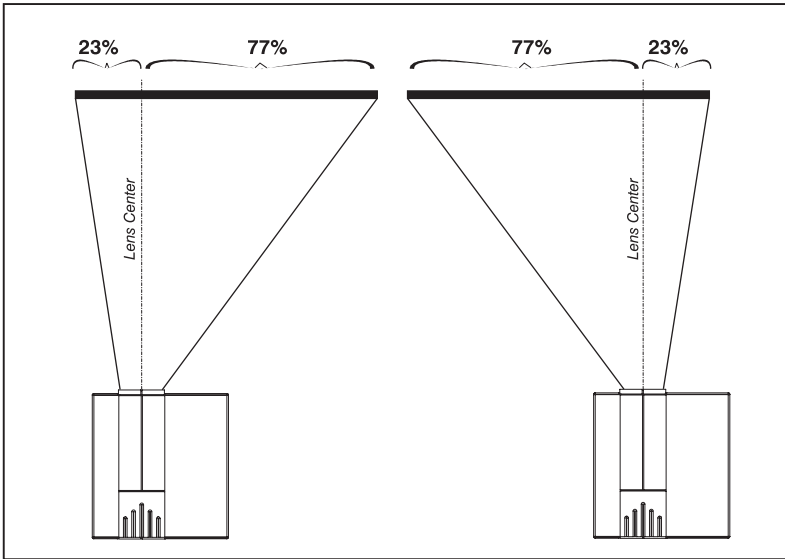

Maximum Horizontal Offset (ALL LENSES)

2.7 Mounting

For typical front or rear floor mounts, mount the projector on a secure table or cart. Take care with a mobile cart-avoid sudden stops, excessive force and uneven surfaces that may cause the projector and cart combination to overturn.



The table or cart should be reasonably level. Fine adjustments to the projector level can be made by adjusting the height of the projector legs.

Special Mounting

Note that projector can be rotated and mounted at any vertical angle-i.e., you can tilt the face of the projector up or down as much as desired for your installation. The side-to-side tilt, however, must not exceed 15° (see below). This limit ensures that the arc lamp in the projector operates properly and safely. Always make sure that exhaust air from the projector does not vent towards the lens, otherwise you may detect heat waves in your projected image.

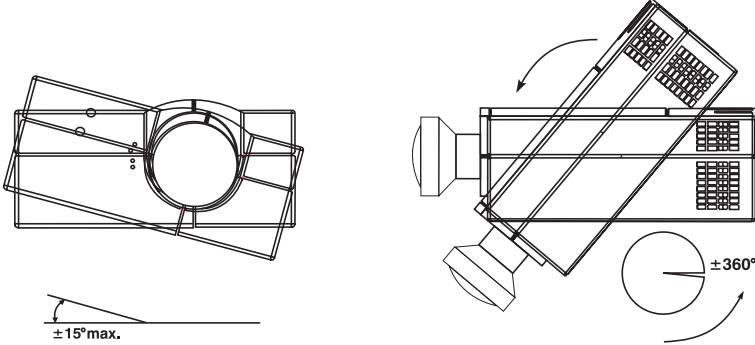

Horizontal and Vertical Tilt Ranges

You must use the proper ceiling mount fixture or stacking kit for your projector. For more information, contact your Runco Dealer.

INSTALLATION AND SETUP

2.8 Folded Optics

In rear screen applications where space behind the projector is limited, a mirror may be used to fold the optical path. The position of the projector and mirror must be accurately set-if considering this type of installation, call your Runco dealer for assistance.

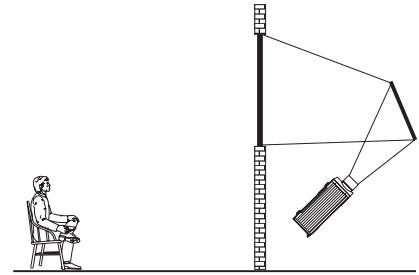

2.9 Source Connections

The rear panel of the projector provides standard input panels to which you may connect a variety of sources. See below - the lower left area (**INPUT 1**) typically accepts an *RGB signal* from an external RGB source (such as the VHD Ultra Controller), or it can also be used for YPbPr signals from DTV sources. The upper right panel-the *Video Decoder Module*-accepts only composite video at **INPUT 3** or *S-video* at **INPUT 4** from devices such as VCRs, laser disc players or DVD players. There are also several optional interfaces available for connecting other sources at **INPUT 2**. Such an option installs in the upper left area, just below the audio connectors. For any input, including the optional inputs, audio with loop through connects at the audio input panel located between the license label area and **INPUT 2**.

Note: The decoder module is an option; it is not supplied with the Projector.

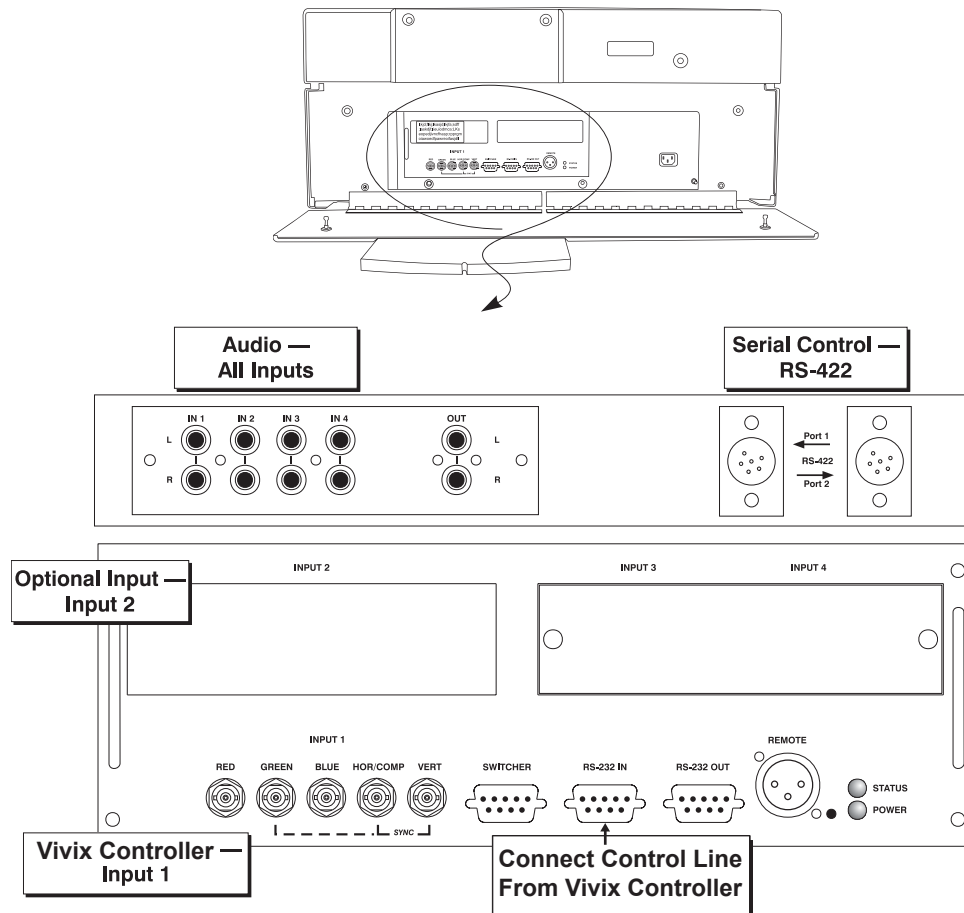

Rear Connector Panel

INSTALLATION AND SETUP

2.10 RGB Signals

INPUT 1 provides 5 BNCs (connectors) for linking to a variety of sources. The typical connection would be to an RGB source such as the VHD Ultra Controller, computers or DTV decoders with an RGB output. This projector supports multiple sync types with RGB signals: sync-on-green, composite sync, and separate H & V syncs.

NOTES: Depending on the source, you may need a custom adapter cable that has BNC connectors at the projector end and a different type of connector at the other (such as a 15-pin “D” connector for computer sources). Contact your Runco dealer.

Connect the **SYNC** BNC input(s) first. Then connect the red, green and blue source outputs to the **RED**, **GREEN**, and **BLUE** BNCs on the **INPUT 1** panel. If the source uses sync-on-green, only the red, green, and blue connections are required. If the source provides a composite sync output, connect it to the **SYNC** input labeled **HOR/COMP**. If the source provides separate horizontal and vertical sync outputs, connect horizontal sync to the **SYNC** input labeled **HOR/COMP** and connect vertical sync to **SYNC** input labeled **VERT**. See below.

*NOTE: To connect YPbPr signals, such as from analog HDTV sources, to **INPUT 1**, use the red, green and blue BNCs as described in **YPbPr Signals** later in this section.*

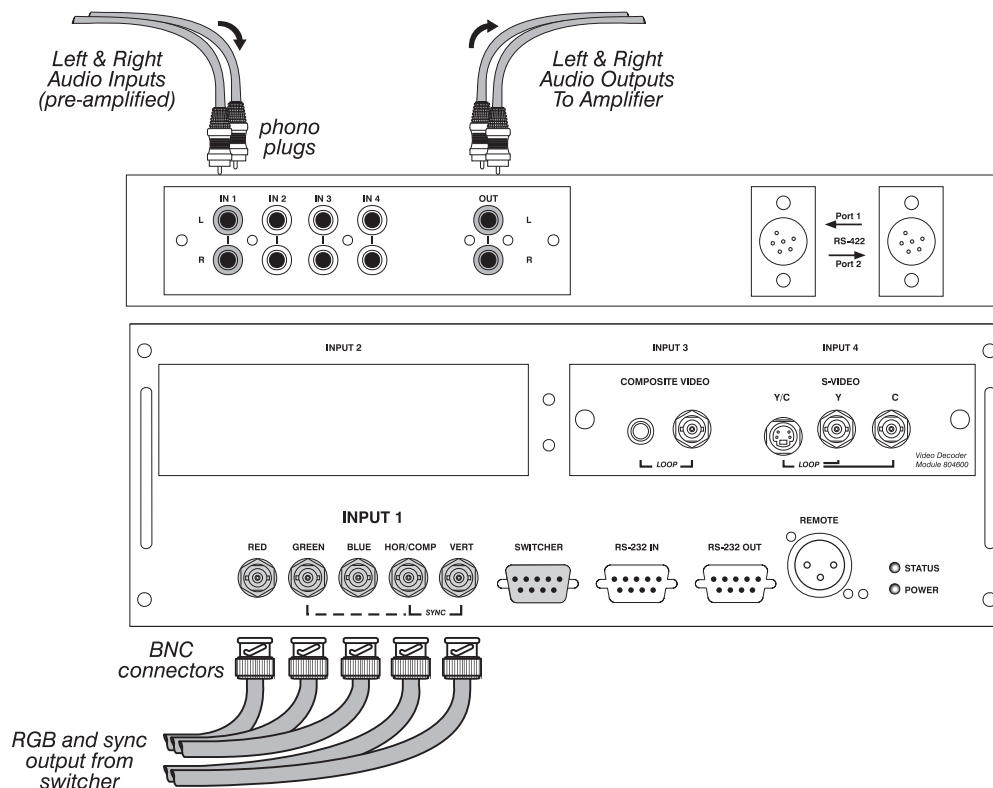

Connecting RGB Input

AUDIO for INPUT 1: To control audio levels in an audio/visual system, connect pre-amplified (line level) audio inputs to the “**IN 1**” left and right channel audio inputs located near the top left corner of the rear input panel. Then connect external audio amplification equipment to audio “**OUT**” for sound output. Audio connection cables require standard RCA type phono plugs.

INSTALLATION AND SETUP

2.11 Keypad Protocols and Conversion

The keypad is assigned “A” as its default protocol, which is simply a collection of settings that determine how the keypad operates. Once assigned, this protocol remains in effect until it is changed—that is, the keypad will operate as it currently does until you change its protocol.

Protocols are most useful for multiple-projector applications. For example, you might want to change a keypad protocol if you are working with two projectors and two remote keypads in the same room and need to control each projector independently (see below). When Keypad A has a different protocol than Keypad B, each keypad communicates only with the projector having a matching protocol. Or, if you have a network of two or more projectors connected together via RS-232 serial ports, you may want only certain projectors to respond to a wired keypad, thus you can use different protocols to limit responses.

*NOTE: Matching the protocol on the projector to that of a keypad is done through a setting in the **Serial Setup** menu. See 3.7, **Adjusting System Parameters and Advanced Controls** for further information on how to change the projector’s infrared sensor (rear and front) protocol.*

A protocol for either type of remote keypad - IR or wired - can be changed through software commands entered on the keypad. A new protocol set through software commands remains in effect until the keypad batteries are removed and replaced (if an IR remote), or until the keypad is unplugged (if a wired remote). A remote can also be changed manually -you can “hard-wire” new jumper settings inside the keypad so that they remain in effect until you change the hard-wiring. A hard-wired protocol can be temporarily overridden by the software protocol change, effective until the keypad is unplugged and plugged in again (if a wired remote) or until a battery is removed (if an IR remote).

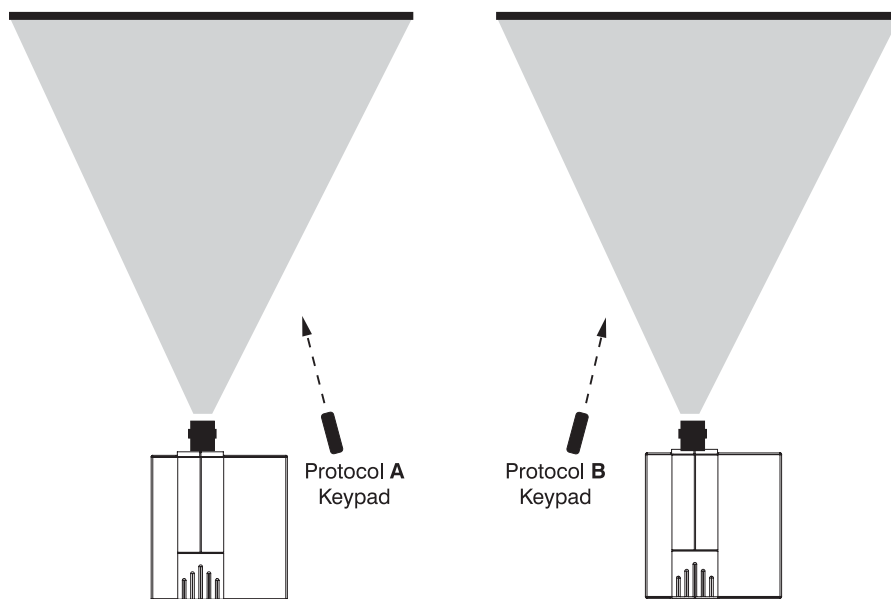

Independent Keypads and Projectors

INSTALLATION AND SETUP

Remote Keypad ▶ Protocol - IR OR WIRED KEYPAD -

The standard IR remote keypad or the optional wired remote can be set to one of two different protocols - “A” or “B”. To hard-wire a protocol to “A” or “B” in either remote, follow Steps 1 through 5:

Step 1 ▶▶

Unplug the keypad from the projector (applies to wired remote only).

Step 2 ▶▶

Unlatch and open the empty battery compartment on the back of the keypad as shown below.

NOTE: A wired keypad opens as shown, but a cable passes through the battery compartment cover.

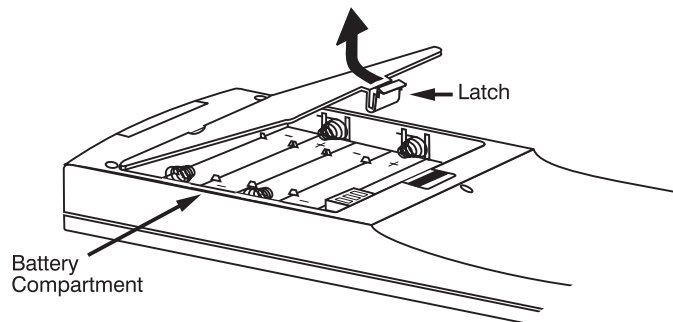

Opening the Keypad

Step 3 ▶▶

Find the 4 jumpers located along the latching side of the battery compartment. These jumpers set the keypad protocol and other settings so that the keypad functions in a certain manner.

Step 4: ▶▶ Set the Jumpers

Set the jumpers as shown on the following page. Take care to refer to the correct part of the drawing - IR or wired (optional). Use tweezers or needle-nose pliers to remove and replace each jumper as necessary.

INSTALLATION AND SETUP

- **J1 jumper:** For either remote, set between pins 1 and 2 to set as Protocol “A”. Set between pins 2 and 3 to set as Protocol “B”.
- **J2 jumper:** For either remote, set between pins 2 and 3 as shown; otherwise, the projector will not respond correctly to keypad commands.
- **J3 jumper:** For the IR remote, make sure that the jumper is set between pins 2 and 3 as shown. For the wired remote, make sure that the jumper is set between pins 1 and 2 as shown.
- **J4 jumper:** For the IR remote, make sure that the jumper is set between pins 1 and 2 as shown. For the wired remote, make sure that the jumper is set between pins 2 and 3 as shown.

Step 5 ►►

Replace battery compartment cover. Plug into projector (wired keypad only) and test.

IR Remote Keypad:	
JP1	<div style="display: flex; justify-content: space-between; font-size: 8px;"> 321 </div> <div style="display: flex; justify-content: space-between; align-items: center;"> <div style="border: 1px solid black; width: 10px; height: 10px; margin-right: 2px;"></div> <div style="border: 1px solid black; width: 10px; height: 10px; margin-right: 2px;"></div> </div> = PROTOCOL A -or- <div style="display: flex; justify-content: space-between; font-size: 8px;"> 321 </div> <div style="display: flex; justify-content: space-between; align-items: center;"> <div style="border: 1px solid black; width: 10px; height: 10px; margin-right: 2px;"></div> <div style="border: 1px solid black; width: 10px; height: 10px; margin-right: 2px;"></div> </div> = PROTOCOL B
JP2	<div style="display: flex; justify-content: space-between; font-size: 8px;"> 321 </div> <div style="display: flex; justify-content: space-between; align-items: center;"> <div style="border: 1px solid black; width: 10px; height: 10px; margin-right: 2px;"></div> <div style="border: 1px solid black; width: 10px; height: 10px; margin-right: 2px;"></div> </div> (ALWAYS)
JP3	<div style="display: flex; justify-content: space-between; font-size: 8px;"> 321 </div> <div style="display: flex; justify-content: space-between; align-items: center;"> <div style="border: 1px solid black; width: 10px; height: 10px; margin-right: 2px;"></div> <div style="border: 1px solid black; width: 10px; height: 10px; margin-right: 2px;"></div> </div> DISABLE IR
JP4	<div style="display: flex; justify-content: space-between; font-size: 8px;"> 321 </div> <div style="display: flex; justify-content: space-between; align-items: center;"> <div style="border: 1px solid black; width: 10px; height: 10px; margin-right: 2px;"></div> <div style="border: 1px solid black; width: 10px; height: 10px; margin-right: 2px;"></div> </div> WIRED KEYPAD

Wired Keypad:	
JP1	<div style="display: flex; justify-content: space-between; font-size: 8px;"> 321 </div> <div style="display: flex; justify-content: space-between; align-items: center;"> <div style="border: 1px solid black; width: 10px; height: 10px; margin-right: 2px;"></div> <div style="border: 1px solid black; width: 10px; height: 10px; margin-right: 2px;"></div> </div> = PROTOCOL A -or- <div style="display: flex; justify-content: space-between; font-size: 8px;"> 321 </div> <div style="display: flex; justify-content: space-between; align-items: center;"> <div style="border: 1px solid black; width: 10px; height: 10px; margin-right: 2px;"></div> <div style="border: 1px solid black; width: 10px; height: 10px; margin-right: 2px;"></div> </div> = PROTOCOL B
JP2	<div style="display: flex; justify-content: space-between; font-size: 8px;"> 321 </div> <div style="display: flex; justify-content: space-between; align-items: center;"> <div style="border: 1px solid black; width: 10px; height: 10px; margin-right: 2px;"></div> <div style="border: 1px solid black; width: 10px; height: 10px; margin-right: 2px;"></div> </div> (ALWAYS)
JP3	<div style="display: flex; justify-content: space-between; font-size: 8px;"> 321 </div> <div style="display: flex; justify-content: space-between; align-items: center;"> <div style="border: 1px solid black; width: 10px; height: 10px; margin-right: 2px;"></div> <div style="border: 1px solid black; width: 10px; height: 10px; margin-right: 2px;"></div> </div> DISABLE IR
JP4	<div style="display: flex; justify-content: space-between; font-size: 8px;"> 321 </div> <div style="display: flex; justify-content: space-between; align-items: center;"> <div style="border: 1px solid black; width: 10px; height: 10px; margin-right: 2px;"></div> <div style="border: 1px solid black; width: 10px; height: 10px; margin-right: 2px;"></div> </div> WIRED KEYPAD

Locating and Setting the Jumpers

NOTE: A wired keypad can be converted into an IR remote keypad, and vice versa. Follow the settings shown above, adding or deleting the cable and batteries as required. The cable with 3-pin XLR connector is available separately from your dealer.

SHORTCUT METHOD:

You can also issue software protocol settings through the keypad. These software commands will be lost when the keypad is either unplugged or when a battery is removed - the keypad will revert back to the hard-wired jumper settings (see above) until you enter the software commands again.

Press = Protocol "A"
Press = Protocol "B"

NOTE: If you change any keypad to a new protocol and the projector stops responding, the projector may be set to a conflicting protocol. Use the projector's built-in keypad to access the Serial Setup menu. Under "Front IR" or "Back IR" or "Wired Keypad", select the protocol that matches the new protocol of the keypad at hand. The projector should now respond properly.

2.12 Converting a Keypad

If desired, you can convert an IR remote keypad into a wired remote keypad and vice versa.

TO CHANGE FROM INFRARED TO WIRED:

- Remove battery compartment cover from back of keypad.
- Remove batteries.
- Wait 1-2 minutes.
- Plug the keypad cable (available separately) into the empty battery compartment. Make sure that the battery cover is notched smoothly to accommodate the cable.
- Set keypad protocol as desired, using "wired" jumper settings.
- Replace battery compartment cover.
- Plug into the 3-pin XLR port at the rear panel of the projector.

TO CHANGE FROM WIRED TO INFRARED:

- Unplug the keypad from the projector.
- Open the keypad back and unplug the keypad cable.
- Wait 1-2 minutes.
- Install batteries (see *Section 4.3*).
- Set keypad protocol as desired, using "IR" jumper settings.
- Replace battery compartment cover.

INSTALLATION AND SETUP



2.13 ISF 3C Calibration

The Splash Screen:

This screen appears for 10 sec. upon startup everything it shows customer name and calibrator's name. It is the seal of a properly calibrated projector.



From Runco Digital Home Cinema, select Installation use *passcode 3151 for access.*

Then select Operational Parameters from the menu items. Once in the Operational Parameters menu select **ISF C3 Calibration**. The menu will appear as shown to the right:

- Use to select characters
- Use to move cursor
- Use to accept input data

ISF C3 Calibration	
Customer Name	J. Chan
Calibrator Name	Andy S.
Date of Calibration	11/17/03
Next Calibration	11/17/04

Note: 3151 Passcode

How to select day / night color balance modes:
For Image Adjust menu see page 3-22

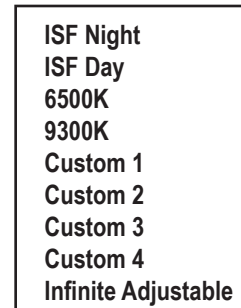

INSTALLATION AND SETUP

How to read and reset the calibration counter. From Runco Digital Home Cinema select Information to read time elapsed since last calibration reset counter from Operational Parameters Menu.

Information			
Customer Name	J. Chan	<div style="border: 1px solid black; padding: 2px; display: inline-block;">Scroll to see more</div> 	
Calibrator Name	Andy S.		
Date of Calibration	11/17/03		
Next Calibration	11/17/04		
Name	Runco VX-4c / VX-6c		
Serial No.	123456789		
Xenon Lamp Adjust	20	Calibration Counter	5
Projector Hours	152	Resolution	<div style="border: 1px solid black; padding: 2px; display: inline-block;">Hours logged for current period (reset in Operational Parameters)</div>
Memory Bank Label	Sync Type Tri-Level on HC input		
Memory Bank No.	02	Sync	33.75 kHz + 60.00 Hz –
		Sample Rate	120Mhz
IPM	2.3	Software	1.0
Interconnect		Boot	
Panel Driver		Light Engine	
LCD HW		LCD SW	
Decoder			
ACM			

OPERATION

3.1 Overview

This section explains how to use the projector once it has been installed. Please read through these pages before using the projector for the first time. An understanding of projector features and how to access them will help you to take full advantage of the capabilities of the projector within minutes.

*NOTE: Installation involves locating the projector and adjusting it for use at that location. If you have not yet installed the projector, refer to **Section 2, Installation and Setup.***

3.2 Projector Basics

Most projector functions and adjustments are entered through keypad commands that either control the projector directly or activate a system of intuitive menus. Variations in settings can be defined and retained in the projector's internal memory as a custom Memory Bank, with up to 99 different Memory Banks possible.

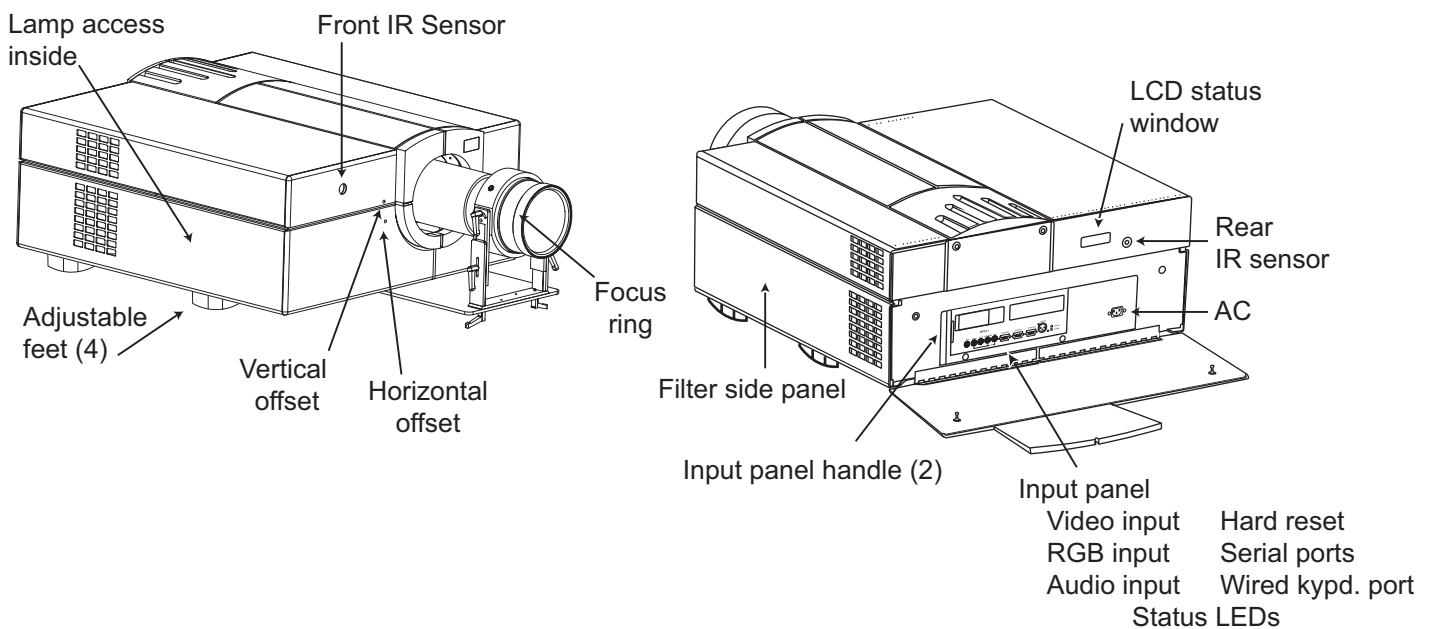

⚠ AC LINE CORD INPUT - The projector requires AC power of 100 to 240 VAC, 50 to 60 Hz (11.5 amps @ 100 VAC, 5.5 amps @ 220 VAC). Always use the line cord that is supplied with the projector-the projector requires this high-current 13A rated cord. See complete power specifications in Section 5.

⚠ WARNING ⚠

Do not attempt operation if the AC supply is not within the specified voltage and power range.

STATUS/POWER LEADS - Two LEDs (light emitting diodes) located in the lower right corner of the rear connector panel indicate projector “Status” (top) and “Power” (bottom). During normal operation, the “Power” light is steady green and the “Status” light flashes green each time a key is pressed or when the projector receives a serial command. Use the following as a guide:

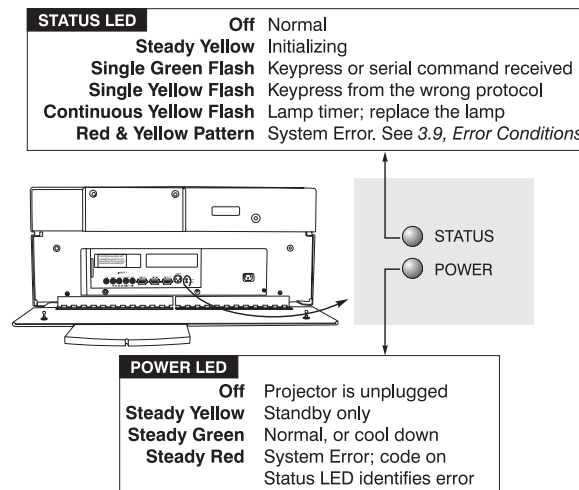

Reading the Status LEDs

*NOTE: A steady red power light accompanied by a coded pattern of red and yellow flashes from the status light indicates an internal system error. Consult the rear LCD display for an explanation, and see 3.8, **Error Conditions**. Should the problem persist, contact your Runco dealer.*

REMOTE WIRED KEYPAD CONNECTOR (3-pin XLR) - For optional tethered remote control of the projector.

LCD STATUS DISPLAY - Visual feedback for monitoring projector activities and status.

INFRARED SENSORS - The infrared (IR) sensors on the front and rear of the projector receive infrared signals from the IR keypad for remote control of projector functions. For proper operation make sure that these sensors are not blocked.

HARD RESET - Emergency access for powering down the projector in the event of a system failure. Insert a pen point or small screwdriver.

OPERATION

3.3 Using the Keypad

The keypad appears in two locations:

- **Infrared (IR) Remote** for wireless control up to 100 feet away
- **Wired Remote** (optional) tethered to the rear of the projector

While each keypad is identical in layout and provides complete control of the projector, you may find one keypad more convenient than another for your specific installation and application.

IR Remote

The IR Remote Keypad controls the projector by way of wireless communications from a battery-powered infrared (IR) transmitter. Use the IR remote keypad the same way you would use a remote keypad supplied with a TV or VCR. When making key presses, point the keypad either toward the screen or toward the front or rear of the projector. One of two sensors on the projector will detect the signals and relay the commands for internal processing.







Wired Remote (OPTIONAL)

The wired remote keypad connects to the 3-pin XLR jack via a 50 ft. cable. It is recommended when:

- the lighting conditions are unsuitable for proper IR transmission
- you want to use a separate keypad for each projector in a group

Guide to Keypads



Keep in mind the following guidelines:

- 1) Press keys one-at-a-time; there are no simultaneous key presses required.
- 2) For any key having an “*” ( for example), hold the key for approximately 1 second in order to toggle the function with a single key press. For other keys (or to use a “*” key in conjunction with  or ), a momentary press similar to a mouse click is sufficient.
- 3) Press the “lightbulb key” to temporarily illuminate the backlight for the keys without sending any other command.
- 4) , , , and  repeat their “arrow” actions when held down. For other keys, release and press again to repeat an action.
- 5) If you press a key while the projector is busy with another action, such as during a power-up, the key press may not take effect.

Keypad Commands

Specific keypad commands are explained below:

Power ON/OFF

Press and hold for approximately 1 second to turn the projector on or off with a single key press. Or press  followed immediately by  or  if you want to guarantee the correct toggle (useful if you are unsure of the present status).

NOTES: 1) Whenever the projector is turned off, the lamp cooling fans remain on for about five minutes to cool the lamp. 2) It is a good idea to avoid turning a projector back on until it has been off for a few minutes. Hot re-strikes of the lamp may reduce lamp life.

Input 1

Press  to select the source connected to INPUT 1 on the projector (data input). This is the same as entering.

Input2

Input 2

Press to select the source connected to **INPUT 2** on the projector (an optional interface). This is the same as entering .

Input3

Input 3

Press to select the source connected to **INPUT 3** on the projector (composite video). This is the same as entering .

Input4

Input 4

Press to select the source connected to **INPUT 4** on the projector (S-Video). This is the same as entering .

Input

Input

Press when you want to display from a specific source location, such as a switcher connected serially to the projector's switcher port. The first digit represents the number you have assigned to your switcher (usually 1-9, or "0" for one of the four inputs on the projector). The second digit represents the switcher's slot number (1-9). For example:

= display data from switcher 1, slot 2.

*NOTES: 1) Although you do not need to use the input key, you can also use to access the four input "slots" on the projector itself: use as the first digit (representing the projector as the switcher), then , , , or as the second digit (the desired input slot number). In combination with higher numbers is an invalid entry. 2) See 3.5, **Using Channels and Inputs** for a detailed explanation of inputs.*

*NOTE: key behavior during a presentation depends on whether or not the **Memory Bank List** option is selected in the **OSD Settings** menu. You can choose to have on-screen feedback when you press , or you may prefer to enter the desired source location "blind", i.e., without on-screen feedback. See **OSD Settings** later in this section.*

Chan

Memory Bank

Press to select a specific source setup (Memory Bank) defined and stored in projector memory. Once you enter a 2-digit Memory Bank number (or, if there is a list displayed, highlight it and press), the display will automatically change and update according to the numerous setup parameters defined for that Memory Bank.

*NOTE: key behavior during a presentation depends on whether or not the **Bank List** option is selected in the **OSD Settings** menu. You can choose to use a scrollable list of Memory Banks when you press , or you may prefer to enter the desired Memory Bank number "blind", i.e., without on-screen feedback. See **OSD Settings** later in this section.*

Stby*

Standby

Press and hold for approximately 1 second to blank all display and mute the audio output while keeping the projector in a warmed-up and ready state. Or quickly press and release and follow immediately by or if you want to guarantee the correct toggle (useful if you are unsure of the present status). Note that the lamp and electronics remain ON in standby mode, even though the image turns to black and most functions are disabled. To leave standby, press and hold again (or use). Or simply press or .

OPERATION

Menu

Menu

Press **Menu** to display the Runco Digital Home Cinema menu. A list of several options appears for access to specific functions, such as *Memory Banks* or *Image Adjustments*. Press **Menu** again to remove all menus and return to the displayed source.

Enter

Enter

Press **Enter** to select a highlighted item, to toggle a checkbox (checked vs. unchecked), or to accept a parameter adjustment and return to the previous menu or image.

Exit

Exit

Press **Exit** to return to the previous level, such as the previous menu.

NOTE: **Exit** does **not** save changes within text editing boxes (including number editing of a slidebars) or within pull-down lists. It acts as a "cancel" in these cases.

Arrow Keys

The arrow keys have a variety of functions depending on the situation. Some typical uses are described below. See also *Editing Text* later in Section 3.

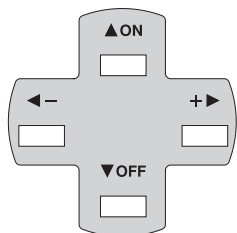

- Use **◀-** or **+▶** to change a slider value-hold as desired for continuous adjustment (*note the adjustment increments and range depend on the parameter being adjusted*).
- Use **◀-** or **+▶** to change to a different option within a pull-down list without having to display the list first.
- Use **◀-** or **+▶** to jump between "pages", such as in *Help* or lengthy pull-down lists.

▲ON

Or

▼OFF

Use the **▲ON** or **▼OFF** keys to navigate within a menu, pull-down list or text box, or to increase or decrease the value in the second (bottom) sidebar of a double sidebar.

You can also use **▲ON** or **▼OFF** in conjunction with certain *toggle* keys-i.e., those including an asterisk symbol-to ensure a toggle *only* in the desired direction. When turning the projector on, for instance, you may be too far from the projector to know whether it is really off or if the shutter is merely closed. If you press **Power*** and hold it for approximately 1 second in hopes of turning the projector *on*, the projector will actually turn *off* if the projector was already on. Instead, to avoid the risk of toggling in the wrong direction, quickly press *and release normally* the function key you wish to toggle (in this case **Power***). Then immediately (within 2 seconds) press either **▲ON** or **▼OFF** as desired. The specific toggle will occur.

Toggle keys are labeled with an asterisk on the keypad. They are listed below:

- **Shutter*** + **▲ON** = close the shutter (OPTIONAL)
- **Shutter*** + **▼OFF** = open the shutter (OPTIONAL)
- **Stby*** + **▲ON** = put the projector in standby mode
- **Stby*** + **▼OFF** = leave standby
- **Power*** + **▲ON** = turn the projector on
- **Power*** + **▼OFF** = turn the projector off

- | | | | | |
|-------|---|------|---|-------------------------------------|
| Mute* | + | ▲ON | = | turn the audio and menu display on |
| Mute* | + | ▼OFF | = | turn the audio and menu display off |
- | | | | | |
|------|---|------|---|--------------------------|
| OSD* | + | ▲ON | = | turn the menu system on |
| OSD* | + | ▼OFF | = | turn the menu system off |

Color

Color

Press Color to adjust the color saturation level, i.e. the amount of color in a video image. Lower settings produce less saturated colors - a setting of "0" produces a black and white image, for example. If the color level is too high, colors will be overpowering and unrealistic. Use ◀- and +▶ until the +▶ desired color saturation level is displayed. This is not used when an RGB source is input.

Tint

Tint

Press Tint to adjust the red/green color hue for true color reproduction of NTSC video signals. For best results, adjust tint while displaying a proper test pattern - otherwise, it is recommended that tint remain at its default setting. Use ◀- and +▶ until the desired tint is displayed. This is not used when an RGB source is input.

Detail

Detail

Press Detail to adjust the sharpness of a video image (it is of limited use for non-video). Use ◀- and +▶ until you reach the desired level of detail, keeping in mind that any level of detail above 3 will also introduce a certain degree of noise in the image. Set below 3 to filter the signal and remove noise from a noisy source. This is not used when an RGB source is input.

Cont

Contrast

Press Cont to increase or decrease the difference between light and dark areas of your image. Use ◀- and +▶ until you reach the desired level of contrast, making sure that the whites remain bright but not distorted or tinted (i.e., "crushed").

Bright

Brightness

Press Bright to increase or decrease the amount of perceived light in the image so that black just changes to very dark gray. Use ◀- and +▶ until you reach the desired level. *See 3.6, Adjusting the Image (Scaling Parameters subsection).* Avoid "crushing", or distorted blacks and/or whites.

Vol

Volume

Press Vol to control the audio level. Use ◀- and +▶ until you reach the desired volume.

Pixel

Pixel

Press Pixel to access the pixel tracking and pixel phase double slider. Adjust pixel tracking first: use ◀- and +▶ to increase or decrease the frequency of the pixel sampling clock to correct consistency of the image. For proper phase, use ▲ON and ▼OFF to increase or decrease pixel phase so that any shimmer disappears and the image is stable throughout. *See 3.6, Adjusting the Image (H & V Scaling subsections)* for a complete explanation of tracking and phase.

OPERATION

Position

Position

Press **Position** to move the image using the double slider. At the slider, use **←** and **→** to move the image left or right, use **▲ON** and **▼OFF** to move the image up or down.

Shutter*

Shutter (OPTIONAL)

If your projector has a mechanical lens shutter (a.k.a. dowsler) installed, press and hold **Shutter*** for approximately 1 second to toggle the shutter closed or open with a single key press (this also blanks the image electronically). Or quickly press and release **Shutter*** and follow immediately with **▲ON** or **▼OFF** if you want to guarantee the correct toggle (useful if you are unsure of the present status). Close the shutter whenever you want to mute all display yet maintain access to projector functions. Open the shutter to regain the display. With no shutter installed, **Shutter*** still blanks the image electronically, but the blanking is not quite as black.

NOTES: 1) The status of the shutter is shown in the LCD window on the rear panel of the projector. 2) Upon power-up, the shutter is open. 3) The lamp remains on.

Mute*

Mute

Use **Mute*** to mute audio and/or hide the current menu. Press **Mute*** and hold for approximately 1 second to toggle the audio on or off with a single key press. Or quickly press and release **Mute*** and follow immediately with **▲ON** or **▼OFF** if you want to guarantee the correct toggle (useful if you are unsure of the present status). In either case, a small message appears on screen to signify mute status.

Func

Function Key

When no menus are on-screen or active, press **Func** followed by a 2-digit number to enable a specific color or colors in the display. For example, **Func** **6** **4** will display only red and green data, **Func** **6** **7** will display all colors data. The list of available color combinations is shown below and also appears on the back of the IR remote keypad. DMD enabling can also be accessed through the menu system rather than these shortcuts.

Func	6	1	= Red
Func	6	2	= Green
Func	6	3	= Blue
Func	6	4	= Red and Green
Func	6	5	= Green and Blue
Func	6	6	= Red and Blue
Func	6	7	= All colors

*NOTE: Once **Func** is pressed (with no OSD present), the projector will not respond to non-numeric entry until 2 digits have been entered or until 5 seconds of inactivity have elapsed.*

Use of the **Func** key within the menu system is noted with the appropriate topic elsewhere in Section 3. For example, press **Func** in the Memory Banks menu to enable deletion or copying of a Memory Bank.

OSD*

OSD (On-screen display)

Press and hold **OSD*** for approximately 1 second to toggle menus on or off (i.e., visible or invisible). Or press **OSD*** followed immediately by **▲ON** or **▼OFF** to guarantee the correct toggle direction (useful if you are unsure of the present status). Note that invisible menus are fully functional.

*NOTES: 1) With OSD on, you can still mute menus, error messages, slidebars, etc. with the appropriate setting in the OSD Settings menu. 2) The status of the **OSD*** key is displayed in the LCD window on the rear panel of the projector.*

Help

Help

Press **Help** for detailed information about any current menu and highlight. Press **Help** again to exit. Press **Help** to access the *General Help* menu consisting of *Using Help, Setup, Keys, Source (Input) Selection* and *Stat/Pwr LEDs*. Press **Exit** to leave *General Help*.

Test

Test

Press **Test** to display one of the available test patterns. Press **Test** again to display the next available pattern in the sequence. **Test** will exit after the last pattern, or press **Exit** at any time to remove the current test pattern from the screen and return to the current external source.

NOTE: For a complete list of all test patterns, see the Advanced menu description later in Section 3.

Keypad operating settings (protocols)

The remote keypad and the optional wired keypad both store keypad operating settings (called *protocols*) in memory. In some advanced applications, such as when you want to use two separate keypads to control two projectors independently, you may want to override the original protocol set at manufacture (which is "A or B") for one of the keypads. See section 2.12, *Keypad Protocols and Conversion* for complete instructions.

OPERATION

3.4 Navigating the Menus

Most of the controls for the projector are accessed from within the projector's menu system. There are several groups of related *functions*, with each group selectable from the *Runco Digital Home Cinema* menu as shown at right. Press **Menu** at any time to display the *Runco Digital Home Cinema* menu.

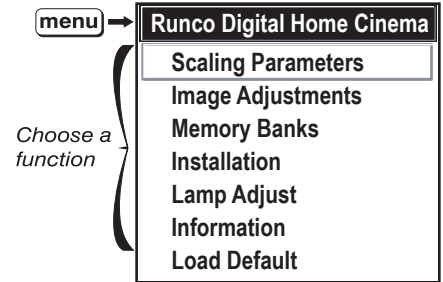

On the keypad, either enter the number corresponding to the function menu you wish to access, such as **2** for the *Image Adjustments* menu, or use the **▲** **▼** keys to highlight the desired option and press **Enter**. The function menu you selected will then appear. If you select "Load Default", this will not activate a separate function menu but rather begin an automated process of optimizing critical display parameters such as size, position, pixel tracking, etc.

Runco Digital Home Cinema Menu

Once you have a function menu displayed, navigate in a similar manner-enter a menu option number for any numbered option, or use **▲** **▼** to move the highlight and press **Enter** at the desired option. Extra long menus have a scroll bar on the right-use the arrow keys to see the remainder of the menu. Items that are locked out or do not pertain to the current action appear dimmed and cannot be selected.

NOTES: 1) *If there is no signal present, all source-dependent adjustments are disabled.* 2) *After 15 minutes of inactivity, the projector leaves the menu system and returns to the presentation.* 3) **The Information menu is read-only.**

When finished with a function menu, do one of the following:

- Press **Exit** to return to the previous screen
- Press **Menu** to leave the menu system and return to the active source.

On-line Help

If at any time you are uncertain what to do next, press **Help** to display detailed information about the current menu or highlighted option. A scroll bar appears on the right-hand side of a help window if there is additional text-use the arrow keys to scroll. Press **Help** again to exit.

Scaling Parameters		
H & V Scaling	1000	<input type="text"/>
V Scaling	1000	<input type="text"/>
Total H Dots	1688	<input type="text"/>
Fine V Dots	15	<input type="text"/>
H - Shift	378	<input type="text"/>
V - Shift	264	<input type="text"/>

With no menus active, press **Help** to access general *Help Topics*. Scroll as necessary within a topic. Press **Exit** to return to the source. At the bottom of some menus, a line of 'hint' text also appears.

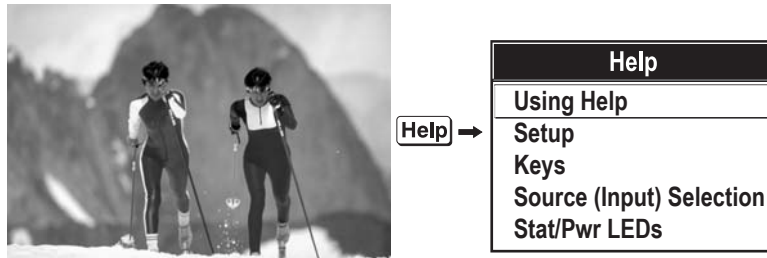

Accessing General Help Topics

Time-outs

Whenever there are on-screen menus such as when there is a sliderbar, menu, message or test pattern displayed, you have limited time in which to make a keypad entry before the graphic disappears. These time-outs vary depending on the current display, as shown in the following chart:

Using Slidebars and Other Controls

<i>TIME OUTS</i>	
<i>ISF 3C Screen</i>	<i>10 seconds</i>
<i>Sliderbar (from pres.)</i>	<i>5 seconds</i>
<i>Sliderbar (from menu)</i>	<i>15 minutes</i>
<i>Lamp Timer Msg.</i>	<i>30 seconds</i>
<i>Channel entry</i>	<i>5 seconds</i>
<i>Other</i>	<i>15 minutes</i>

Most of the function menus allow you to change settings by using slidebars, checkboxes, and pull-down lists. To select a sliderbar, toggle a checkbox status, or view a pull-down list, do one of the following within the function menu:

- Enter the menu option number corresponding to the setting you wish to change (for example, press to select Vertical Scaling in the *Scaling Parameters* menu).
- Or move the highlight to the desired parameter and press .
- Or move the highlight to the option desired and press or .
- Or bypass the menus entirely and use a single key to immediately access an adjustment during your presentation (*note: applies only to options having their own key, such as Color, Tint, Contrast, Brightness, and Volume*).

Once selected, change the setting as desired (see below) and press to save and return to the current function menu.

Slidebars in menus - The current value for a given parameter, such as size or vertical scaling, appears to the left of its sliderbar icon (window). This number often expresses a percentage, or it may have units associated with it (such as pixels, degrees Kelvin, etc.), depending on the specific option. Press or to gradually adjust the setting up or down-both the number and the length of the bar change accordingly (for continuous adjustment, hold down the desired arrow key). Or press to activate a sliderbar text box for specific number entry via the keypad, then press or or to save (or press to cancel).

OPERATION

Double sliders - In double sliders, such as the pixel tracking/pixel phase double slider, adjust the top slider with or as desired. When you have finished with the top slider (whether changed or not), adjust the bottom slider with or . When you are done, press to return to your presentation. For fast continuous adjustments, hold down the desired arrow key.

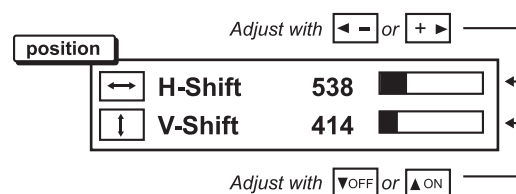

"Direct" sliders - For quick access, you can often use a slider (or double slider) without traveling the menu system. For example, simply press to immediately display the same contrast slider accessed with the **Contrast** option in the *Image Adjustments* menu. Direct sliders are listed below.

LIST OF DIRECT SLIDEBARS	
H-Shift or V-Shift	<input type="button" value="Position"/>
Pixel Tracking or Phase	<input type="button" value="Pixel"/>
Volume	<input type="button" value="Vol"/>
Contrast	<input type="button" value="Cont"/>
Brightness	<input type="button" value="Bright"/>
Color	<input type="button" value="Color"/>
Tint	<input type="button" value="Tint"/>
Detail	<input type="button" value="Detail"/>

Use the arrow keys to adjust a direct slider, or press and enter a specific number from the keypad, then or or to save (or to cancel). When you are done, press to save and return to your presentation.

*NOTES: 1) You can still adjust a direct slider as usual if the menu display is turned off (see or **OSD Settings** menu) - the slider just won't be visible. 2) A direct slider disappears if it is not used within 5 seconds.*

Checkboxes - Conditions are present if its adjacent checkbox contains a checkmark. To toggle the checkbox, simply highlight and press , or highlight and use to check and to uncheck. For a checkbox that is numbered, simply enter the number of the option to toggle the checkbox.

Pull-down lists - To see a pull-down list of options available for a given parameter labeled with a ▼, you can:

- Highlight it and press
- Or enter the menu option number.

Use or keys to navigate up and down within the list (the current choice is noted with a small ▶). Press to choose an option from the list, if desired.

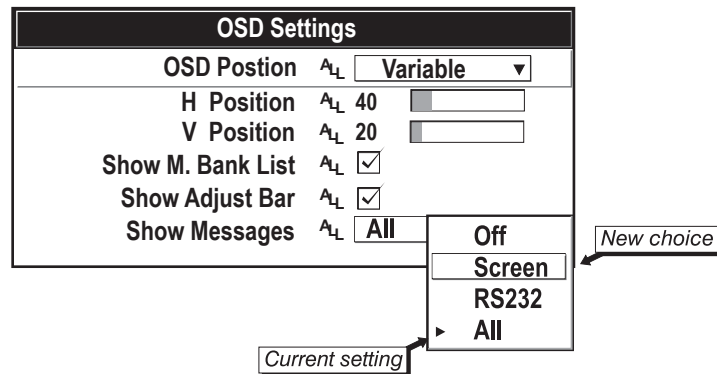

Example of Pull-Down List

Or, if you prefer to quickly scroll through a list without first pulling it down, highlight the option and use **←** or **→**. Press **Enter** when the desired choice appears.

*NOTES: 1) Press **←** or **→** to jump between "pages" in an extra long pull-down list. 2) Press **Enter** while in a pull-down list to **cancel** any change.*

Editing Text

ACTIVATE THE EDIT WINDOW: To enter or edit text, highlight the desired parameter (such as a Memory Bank name) and press **Enter** to activate its adjacent edit window. Any previously entered text is displayed with its first character highlighted in a square cursor, signifying that this character is ready for editing.

NAVIGATE WITHIN THE EDIT WINDOW: Press **→** to move the cursor forward or **←** to move the cursor backwards as desired.

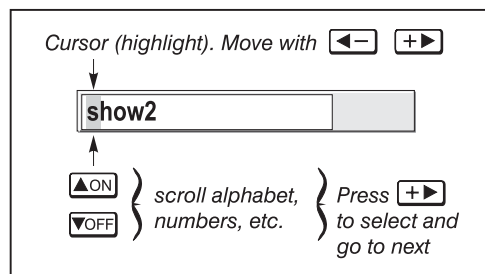

Entering Text

EDIT A CHARACTER: To edit a highlighted character, use **▲** and **▼** to scroll through the alphabet, numbers, spaces and punctuation available. When the character you need appears, press **→** to select it-the cursor will move to the next character of current text, if present. Note that you can also enter a number directly from the keypad-it will be accepted and the cursor will move on.

ADD OR DELETE A CHARACTER OR SPACE: To insert a space at the cursor location, press **Func** **→**. To delete a highlighted character (or space), press **Func** **←**.

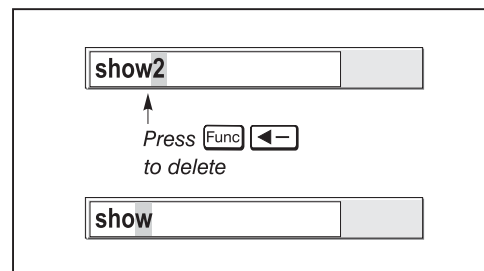
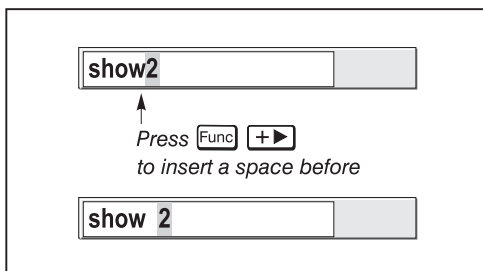

PRESS **Enter WHEN FINISHED:** To accept the edits and move out of the edit window, press **Exit**.

OPERATION

NOTE: Press at any time to cancel changes and return to the previously-defined text.

Editing Numerical Values ►►

Enter numbers directly from the keypad in order to specify numbers representing projectors, Memory Banks (source setups), switchers, or slots. As each digit is entered, it is displayed and the cursor moves on. Note that Memory Bank numbers are defined with 2 digits—for example, if you enter only a single digit (like "7") for a Memory Bank number, the Memory Bank will automatically be defined as "07". Use "07" to utilize this Memory Bank.

NOTE: 1) Once you enter the first digit, this digit replaces all old digits. 2) If you press any non-numbered key, the number entered up to that point is accepted and updated as the new value. 3) Press to cancel editing of numerical values.

3.5 Using Inputs and Memory Banks

*NOTE: See **Section 2, Installation and Setup**, for a full explanation of how to connect a variety of sources to the projector.*

The projector stores and automatically recalls up to 99 different Memory Banks (source setups) for a variety of inputs. This memory feature allows you to define and conveniently use a wide variety of customized setups rather than having to repeatedly re-configure the projector for different presentations. Each physical source (i.e., *input*) can have several different Memory Banks associated with it.

Selecting an Input ►►

INPUT - An input simply describes a physical location for an incoming signal connection. These connections are always either on the projector itself (one of the four inputs at the rear of the projector).

EXAMPLE:

= use source connected to the projector, slot #1 (i.e.,)

Pressing the appropriate direct key - , , , or - is a quick and seamless way to display from one of the four inputs connected at the rear of the projector.

If it is the first time you have used the source/input (or if you used the input but did not define a Memory Bank by adjusting anything), the projector will recognize the new input signal based on its frequencies and polarities, and will automatically display an image according to default settings for such a signal. Note that a graphic source will resize into a full-screen image, whereas video or HDTV sources will resize only as much as possible while maintaining their aspect ratio.

If you used the source once before and changed a display parameter such as contrast, V-Shift etc., then a Memory Bank was automatically created and still exists in projector memory (see below). Using an key will automatically recall this Memory Bank - and all its setup parameters - and update the display accordingly.

If more than one Memory Bank exists for the input, the image will be displayed according to the setup parameters for the first Memory Bank with matching characteristics.

MEMORY BANK - A Memory Bank is a collection of measurements, locations and settings that tailor a display to your specific needs. Since source types and applications can vary greatly, you will likely want to adjust and define a wide variety of parameters, such as brightness, contrast, tint, size, etc., in order to customize and optimize the display coming from a particular source. For example, the display settings you choose for a VCR source may be very different from those you choose for a high resolution computer source, or one signal may simply vary from another signal used earlier through the same input location. Once you have adjusted a display parameter, such as pixel tracking or contrast, all current settings are collectively stored in the projector's memory as a unique 2-digit Memory Bank, such as . You can have numerous distinct Memory Banks available for the same input, any of which can be selected by using the key on the keypad followed by the 2-digit Memory Bank number.

*NOTE: The key may display a Memory Bank list or not, depending on what you have defined within the **OSD Settings** menu (see **OSD Settings** later in this section). Shown at right is a sample Memory Bank list available from .*

In order to use Memory Banks (on the keypad), you must first create them. See below.

Creating a New Memory Bank **▶▶** - AUTOMATIC -

To use a new source with the projector, a new Memory Bank must be added to projector memory so that the projector will respond properly to an input signal from that source in the future. A new Memory Bank can be created automatically, as described here, or it can be copied from an existing Memory Bank and then edited as necessary (see ***Copying or Deleting Memory Banks*** later in this section).

When you select a direct input (press or , , , or), the existing Memory Banks in the projector are searched for matching input and signal parameters. If no match to the incoming input signal is found in the currently defined Memory Banks, a new Memory Bank is temporarily created based on factory-defined defaults for this signal. The *Memory Bank Number* assigned to this Memory Bank is the lowest available number from 01-99.

*NOTES: 1) An automatic Memory Bank will be discarded unless one or more of its parameters are changed, and will not appear in the **Bank List** (see below). 2) If two Memory Banks have the same distinguishing source characteristics except for the reversal of sync connectors (i.e., H-sync and V-sync, are switched), they are still defined as distinct Memory Banks. 3) You cannot define a new Memory Bank without a signal present.*

If the incoming signal *does* match an existing Memory Bank, the image will be set up and displayed as usual according to the parameters currently defined for that Memory Bank.

OPERATION

USING A MEMORY BANK: You can normally select a Memory Bank at any time by pressing **[Chan]** (see right). If you want to prevent a Memory Bank from appearing in this list, you must edit the Memory Bank as described in *Memory Banks* later in this section. Such a Memory Bank can still be selected by entering its number as shown at right.

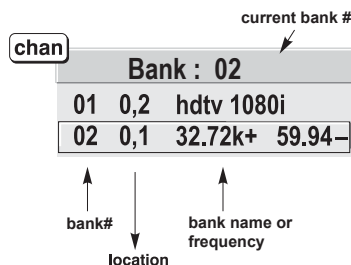

NOTE: 1) The current Memory Bank is highlighted upon entering the **Bank List**, or, if this Memory Bank is not displayed in the list, the first Memory Bank in the list is highlighted. 2) Memory Banks created automatically do not appear in the **Bank List** unless a parameter has been changed.

What Memory Banks Are Defined So Far?

All available Memory Banks are listed in the *Memory Banks* menu, which describes how each Memory Bank can be accessed and that serves as the gateway for editing, copying and deleting Memory Banks.

Press **[Menu]** to display the *Runco Digital Home Cinema* menu. To display the *Memory Banks* menu, press **[3]**, or move the highlight to the *Memory Banks* option and press **[Enter]**. The *Memory Banks* menu will appear (see sample at right), with the active Memory Bank highlighted.

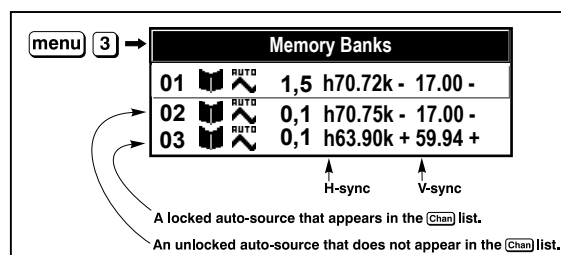

All Banks Appear in the Memory Banks Menu

This menu lists all Memory Banks defined so far and indicates how they are connected to the projector. The far left column contains current Memory Bank numbers defined. The values in the far right columns indicate horizontal and vertical frequencies-if a name has been defined for this Memory Bank, it appears here instead. Other columns contain details pertaining to each Memory Bank setup, such as its switcher number, slot location and a variety of icons indicating access to the Memory Bank. See *Editing a Memory Banks* for details.

If you have more than a handful of Memory Banks, use **[Left Arrow]** and **[Right Arrow]** to see the remaining Memory Banks not visible in this initial display.

To copy, delete or edit any of the Memory Banks listed in the *Memory Banks* menu, highlight the desired Memory Bank and do one of two things:

- Press **[Func]** if you want to copy the selected Memory Bank or delete this or other Memory Banks. See *Copying or Deleting a Memory Bank*, on the following page.
- Press **[Enter]** if you want to edit Memory Banks setups (i.e., non-image related parameters) for the selected Memory Bank. See *Editing a Memory Bank*, on the following page.

Copying or Deleting Memory Banks ▶▶

TO COPY A MEMORY BANK, highlight the desired Memory Bank in the *Memory Banks* menu, then press **[Func]** to go to the *Memory Bank Copy/Delete* submenu. Select "Copy Current" and press **[Enter]** - a new Memory Bank will be created. It is identical to original, which still remains, but it is identified with the next available number from 01-99. If you change your mind and do *not* want to copy the current Memory Bank, press **[Exit]** to cancel and return to the previous menu. Copying Memory Banks is a quick method for creating numerous Memory Banks, each of which can then be edited and adjusted for a variety of presentations in the future.

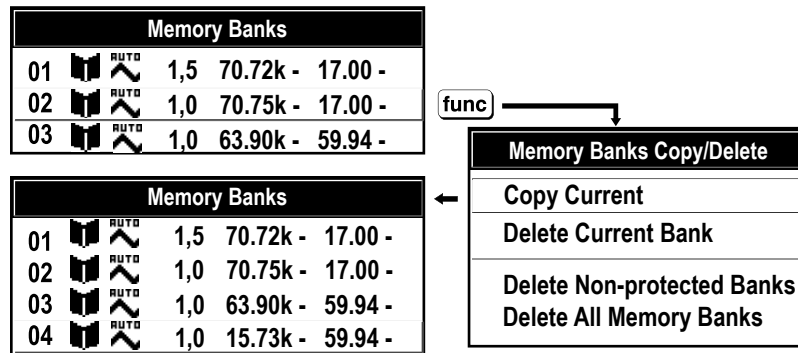

Copying A Memory Bank

TO DELETE A MEMORY BANK, highlight the desired Memory Bank in the *Memory Banks* menu, then press **[Func]** to activate the *Memory Bank Copy/Delete* submenu. Select "Delete Current Bank" and press **[Enter]** - a confirmation window will appear to make sure that you really want to delete this Memory Bank.

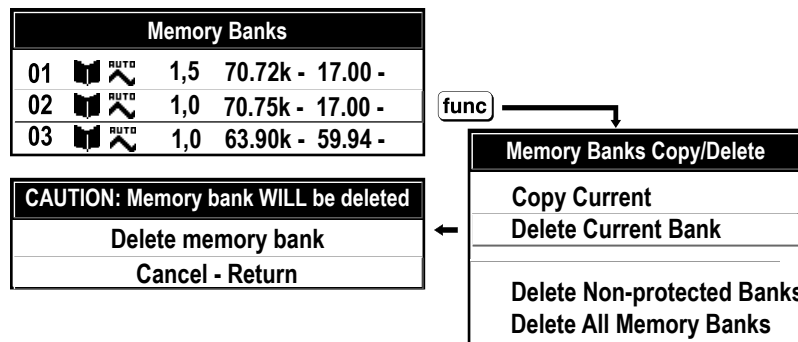

Deleting a Memory Bank

TO DELETE MULTIPLE MEMORY BANKS, highlight any Memory Bank in the *Memory Banks* menu and press **[Func]** to go to the *Memory Bank Copy/Delete* submenu. Select "Delete non-protected Banks" and press **[Enter]** to delete all unlocked Memory Banks. Or select "Delete All Memory Banks" to delete all Memory Banks, even those that are locked. In either case, the current Memory Bank will remain but will be redefined from projector defaults.

NOTE: For any deletion, a confirmation box appears to make sure that you really want to delete. Select "Cancel" (default) if you don't want to delete after all.

Editing a Memory Banks

The basic setups that describe how and where a Memory Bank can be accessed are listed in the *Memory Banks* menu. These Memory Bank setups can be edited at any time in the *Memory Banks* submenu.

OPERATION

MEMORY BANK EDIT - STEP 1

Press **[Menu]** to display the main menu. To display the *Memory Bank Setup* menu, press **[3]**, or move the highlight to the *Memory Bank Setup* option and press **[Enter]**. The *Memory Bank Setup* menu will appear.

MEMORY BANK EDIT - STEP 2

To edit parameters shown in the *Memory Bank Setup* menu, select the relevant channel and press **[Enter]**. The *Memory Banks* menu will appear similar to the sample shown below.

Memory Banks		
Memory Label	Sync Type	Seperate H,V
Bank 3	H Freq	-15.73kHz
Switcher 0	V Freq	-59.94Hz
Slot 1	Interlaced	Yes
List <input checked="" type="checkbox"/>		
Auto Sync <input checked="" type="checkbox"/>		
Protect <input type="checkbox"/>		
Last Bank		
Next Bank		

Memory Banks Menu (SAMPLE)

MEMORY BANK - STEP 3

If desired, edit the following channel setups in the *Memory Bank* menu:

- **MEMORY LABEL:** An alpha-numeric label can be defined and/or changed here. Memory Bank names can be up to 12 characters in length.
- **BANK:** A bank number from 01 to 99 can be changed here. *NOTE: If you enter a bank number that already exists, a dialog message appears indicating that this number is already in use-assign a different bank number.*
- **SWITCHER:** “0” represents the projector itself. This will likely always be the case for the VX-4c/VX-6c.
- **SLOT:** 1 (**[Input1]**), 2 (**[Input2]**), 3 (**[Input3]**), or 4 (**[Input4]**) for projector inputs.
- **LIST:** If checked (default, except for automatically defined banks with unchanged parameters), this defined bank will then appear in the list available when **[Chan]** key is pressed. If unchecked, the bank must be accessed via **[Chan]** on the keypad or via the Auto Source function. *NOTE: On-screen display of the bank list is an option that must be set in the OSD Settings Menu.*
- **AUTO SYNC:** If checked, (default), the projector can automatically locate this bank when an incoming input signal matches. If not checked, the projector can locate the selected bank only when it is directly selected via on the keypad-and a change in input signal will not result in a bank change.
- **PROTECT:** If checked, all of the image settings for this bank will be disabled. If unchecked (default), all available settings can be adjusted as desired.

- **NEXT BANK:** Select this option to see or change *Memory Banks* settings for the next bank in the *Memory Bank* list.
- **LAST BANK:** Select this option to see or change *Memory Banks* settings for the last bank in the *Memory Bank* list.

3.6 Adjusting the Image

Most options for image adjustments can be accessed through two menus: *Scaling Parameters* () and *Image Adjustments* (), both of which are listed in the *Runco Digital Home Cinema* menu. While in either of these two menus, you can change settings affecting the image from the current channel by working with the appropriate slidebars, checkboxes and pull-down lists. will always return to the previous menu (or to the presentation, if from the *Runco Digital Home Cinema* menu) and accept any changes you may have made.

From your presentation, you can access any of the individual options in these menus by pressing followed by the appropriate two-digit number representing their location in the menu system. For example, press to quickly access the "color temp" option in the *Image Adjustments* menu.

Note that for certain options, you may prefer to use a "direct key" from presentation level to go directly to a particular option rather than traveling through the menu system at all (*note: this is not available for all display parameters*). For example, press to access the "contrast" slidebar immediately. Press to return to your presentation.

NOTE: 1) To hide the "direct" slidebars only, make sure the *Display Slidebars* option in the **OSD Settings** menu is unchecked. 2) To hide the entire menu system from view, toggle the on-screen display OFF: press and hold the key.

Load Default

If you want the projector to set up the image for you, select "Load Default" from the *Runco Digital Home Cinema* menu. A confirmation box will ask if you really want to continue, in which case display parameters are listed. A "Load Default" can save time in setting up an image, and you can also make further adjustments as desired.

Scaling Parameters

The *Scaling Parameters* menu allows you to increase or decrease the size of your image, change its proportion (aspect ratio), move the image to a specific area of the screen, and refine other related parameters. Use *Scaling Parameters* controls to match the image precisely to the screen size and aspect ratio needed for your application.

Refer to "Using Slidebars and Other Controls" (earlier in this section) if you need help using any of the following slidebars or pull-down lists to alter your image.

Scaling Parameters		
H & V Scaling	1000	<input type="text"/>
V Scaling	1000	<input type="text"/>
Total H Dots	1688	<input type="text"/>
Fine V Dots	15	<input type="text"/>
H - Shift	378	<input type="text"/>
V - Shift	264	<input type="text"/>

Scaling Parameters Menu

OPERATION

Changes made to the *Scaling Parameters* menu are applied immediately and are saved when you exit the menu (press or).

- **H & V Scaling:** Controls the image *width* and *height* in tandem, maintaining the original aspect ratio (proportion) of data from the incoming signal.
- **Vertical Scaling:**
Vertical scaling adjusts the height the image while keeping the width constant. Use Vertical Scaling to display data from the incoming signal in a different aspect ratio.

- **Total H Dots:**

(**SHORT CUT:** Press and adjust the top slidebar.)

Total H Dots adjusts the frequency of the pixel sampling clock, indicated by the number of pixels per line, so that all pixels generated by a particular source are sampled. Proper pixel tracking ensures that the image quality-whether good or poor- is *consistent* across the screen, and that V Dots can be optimized (below).

NOTE: By default, the projector will sample at the correct frequency for most sources.

Total H Dots is adjusted most effectively using a good test pattern, such as a smooth gray consisting of a clear pattern of tiny black and white dots, or a similar “half on, half off” graphic image, such as the *Windows* shutdown screen. Steady flickering or several soft vertical stripes or bands across the entire image indicates poor horizontal dots. Adjust the slidebar until the stripes broaden to the point where one large stripe fills the image. Again, the image may still exhibit some noise. See *Fine V Dots*.

- **Fine V Dots**

(**SHORT CUT:** Press and adjust the bottom slidebar.)

Fine V Dots adjusts the phase of the vertical dots sampling clock relative to the incoming signal. It is used primarily for adjusting RGB inputs.

*NOTE: Adjust Fine V dots **after** Total H dots is properly set.*

Adjust Fine V Dots when the image (usually from an RGB source) shows shimmer or “noise”. Fine V Dots adjustment is done most effectively from within a proper test pattern, such as a smooth gray consisting of a clear pattern of tiny black and white dots, or a similar graphic image. Adjust until the image is stable and each dot is clearly defined. Using the numbers on the slidebar as a guide, you will notice that you can actually stabilize the image at more than one point- i.e., you may find that the image appearance at “11” is identical to the image appearance at “38”, thus you can select either setting.

H-Shift

(**SHORT CUT**: Press and adjust the top sidebar.)

This option moves picture right and left.

NOTE: The value shown represents where the approximate center of the image lies in relation to the total number of pixels available horizontally. This varies widely according to the signal-watch the image while adjusting.

V-Shift

(**SHORT CUT**: Press and adjust the bottom sidebar)

This option moves the picture up and down.

NOTE: The value shown represents where the approximate center of the image lies in relation to the total number of pixels available vertically. This varies widely according to the signal-watch the image while adjusting.

Blanking: Top, Bottom, Left or Right

This submenu blanks (turns to black) the top, bottom, left, or right edge of the image so that any unwanted information is cropped from view. For example, when displaying native size video you may want to blank out a few of the top lines.

Scaling Parameters (2)		
Top Blanking	0	<input type="text"/>
Bottom Blanking	0	<input type="text"/>
Left Blanking	0	<input type="text"/>
Right Blanking	0	<input type="text"/>

Image Adjustments ▶▶

Use any of the following slidebars, pull-down lists or the checkbox to alter your image. Refer to "Using Slidebars and Other Controls" (earlier in this section) if you need help in selecting options and adjustments. Changes made to the *Image Adjustments* menu are applied immediately and are saved when you exit the menu (press or).

Image Adjustments		
Contrast	50	<input type="text"/>
Brightness	50	<input type="text"/>
Sharpness	2	<input type="text"/>
Signal Type	RGB	<input type="text"/>
Color Balance		
Signal Settings		
Input Adjust		

Image Adjustments Menu

OPERATION

Contrast

(SHORT CUT: Press  and adjust the sidebar.)

"Contrast" increases or decreases the perceived difference between light and dark areas of your image (0-100). If contrast is set too high, the light parts of the image lose detail and clarity. If set too low, the light areas will not be as bright as they could be and it may be difficult to distinguish between foreground and background information. Adjust so that whites remain bright but not distorted or tinted. For best results, keep close to 50.

NOTE: If environment lighting changes, it may be necessary to re-adjust both options.



Brightness

(SHORT CUT: Press  and adjust the sidebar.)

"Brightness" increases or decreases the amount of perceived light in the dark part of the image (0-100). If video or data is displayed with a black background, adjust until the background just changes from black to very dark gray. For best results, keep close to 50.

Sharpness

(SHORT CUT: Press  and adjust the sidebar.)

"Detail" adjusts the sharpness of the video image. Use  or  until the display is as sharp as possible, keeping in mind that any level of detail above 3 (default) will increase the level of detail as well as introduce some level of noise in the image. Set below 3 to filter the signal and remove noise from a noisy source. Keep at 3 to apply no detail. *NOTE: DETAIL is not available in the RGB mode.*

Signal Type

This option determines how the color components of an input signal are decoded for accurate color in the display. Selecting a color balance option is useful only for analog signals connected to **INPUT 1** or **INPUT 2**. Although the color space for such a signal is automatically determined by the projector, in some circumstances you may wish to override this and manually set a different color space.

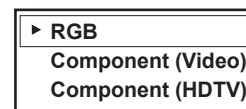

*NOTE: For digital signals or for signals connected to **INPUT 3** or **INPUT 4**, the color space function is entirely automatic and the pull-down list disabled.*

The current color space appears in the Image Adjustments menu. Press  to select a different option:

- Select RGB unless you are using component video at **INPUT 1** or **2**.
- Select **Component Video** (video) if you are using a standard definition televised signal (SDTV)
- Select **Component HDTV** (HDTV) if you are using a high definition decoder (HDTV).

Color Balance

Select this submenu to work with aspects of color - adjust for saturation and overall hue in video signals, or adjust gamma or temperature in any signal.

Color

(**SHORT CUT:** Press and adjust the sidebar.)

“Color” adjusts color saturation level, or the amount of color in a video image. For example, setting Color to “0” produces a black and white image. If Color is set too high, the color levels in the picture will be over-powering and unrealistic. Use or until the desired color saturation level is displayed. *NOTE: COLOR is not available in the RGB mode.*

Tint

(**SHORT CUT:** Press and adjust the sidebar.)

“Tint” adjusts color hue to obtain true color reproduction of NTSC video signals. Use or until you reach optimum balance of red-to-green in your image. It is best to adjust tint while displaying a proper SMPTE color bar test pattern-otherwise, it is recommended that tint remain at its default setting. *NOTE: TINT is not available in the RGB mode.*

Set Color Balance

“Color Balance” applies either a preset color temperature (3200K, 5400K, 6500K, or 9300K) or any previously defined Infinite Adjustable or “Custom” color temperature. All temperatures are measured in degrees Kelvin and represent the “coloration” (reddish or bluish) of the whites displayed by the projector-the lower the temperature, the more reddish the whites, the higher the temperature, the more bluish the whites. *NOTE: Custom temperatures (“Custom” or “Infinite Adjustable”) can be defined in the **Advanced Color Temperature** menu-until then, these choices all default to 6500K. See **Section 3.7, Adjusting System Parameters and Advanced Controls.***

ISF Night
ISF Day
6500K
9300K
Custom 1
Custom 2
Custom 3
Custom 4
Infinite Adjustable

Gamma Curve

NOTE: Gamma does not normally require adjustment and is intended for experienced users only.

The “Gamma Curve” option affects the shape of the gamma curve representing the levels and types of grays available between minimum input (black) and maximum (white). Generally the best gamma curve is one that produces maximum contrast, brightness and color performance. See *Selected Gamma Curves* on the following page.

OPERATION

Gamma Curve

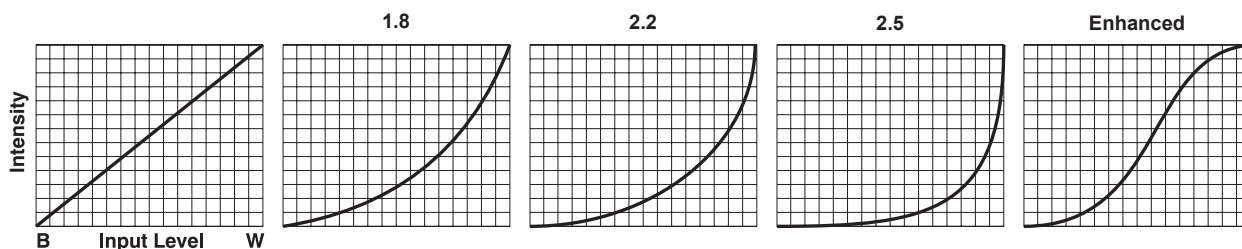

Selected Gamma Curves

THE DEFAULT SETTING OF 2.2 is a normal and smooth gamma curve recommended for virtually all sources, producing good contrast and smooth gray transitions without distorting colors.

THE ENHANCED SETTING elevates middle gray levels compared to “Default”, and provides a more gradual rolled-off transition to maximum white. Together, these differences can improve the appearance of many kinds of images.

THE 1.8 SETTING elevates low gray levels compared to the “Default” and “3.2” settings. In high ambient light conditions, details can be seen in the dark parts of the image that would otherwise be difficult to perceive.

THE 2.5 SETTING results in a darker image with higher contrast. The gamma curve more closely matches the official standard for PAL and SECAM video signals.

THE 1.0 SETTING is a straight, linear transition from black to white. For normal source signals, it results in a picture of low contrast with highly elevated low- and mid-level grays. It should be used only with sources that have their own pre-applied gamma control.

- ▶ 2.2
- Enhanced
- 1.8
- 2.5
- 1.0

3.7 Adjusting System Parameters and Advanced Controls

Use the *Installation*, *OSD Settings* and *Information* menus to display and/or alter overall system parameters rather than those that affect a specific source or channel.

Use the *Advanced* menu whenever you need to work with or replace the lamp, select a test pattern, define a new color temperature, or access lesser-used image control settings intended for experienced users.

Projector Configuration

Choose from Floor Front, Floor Rear, Ceiling Front, Ceiling Rear according to your installation. If the setting is incorrect, the image will be reversed and/or upside down.

OSD Language

Choose from English, French, Spanish, German and Italian language. The menus will change immediately upon selection.

OSD SETTINGS

Use *OSD Settings* checkboxes and pull-down lists to alter how the projector responds to commands and displays its parameters. Refer to the “*Using Slidebars and Other Controls*” subsection if you need help. Changes made to the *OSD Settings* menu will be saved when you exit the menu.

OSD Settings	
OSD Position	Variable
H Position	50 <input type="text"/>
V Position	50 <input type="text"/>
Display M. Bank List	<input checked="" type="checkbox"/>
Show Adjust Bar	<input checked="" type="checkbox"/>
Show Messages	All

OSD Settings Menu

OSD Position

Use the pull down list to choose the pre-defined or customized default location for the display of on-screen menus. To create a custom menu location, choose a preset that is closest to the desired area. Then adjust the sidebars of *H Position* and *V Position* to move the menu to the desired location. To prevent cropping of larger menus, avoid locations too close to a corner or edge.

H Position / V Position

Shift your menus as desired, creating a customized menu location.

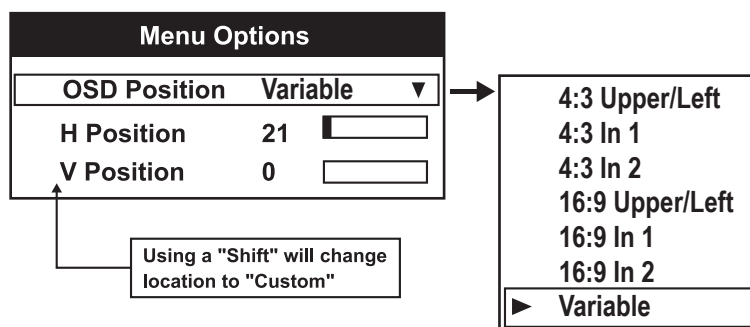

OPERATION

Display M. Bank List

Enter a checkmark if you want to see a scrollable channel list whenever you press Chan from your presentation (note that each channel to be included in the list must also be tagged in the “In Menu” checkbox in the *Memory Banks* menu). This option also enables on-screen feedback when using the Input key. If you prefer to hide the channel list and input dialog box while switching channels and sources during a presentation, do not enter a checkmark.

NOTE: The Bank List and input dialog box cannot be hidden when a menu is displayed.

Show Adjust Bar



Enter a checkmark to superimpose a small sidebar over the current image whenever an adjustable parameter is selected directly with the keypad. If “Show Adjust Bar” is unchecked, these slidebars can still be accessed, but will be hidden during adjustment.

Show Message

Choose in what way you want to be notified of errors detected in either the incoming signal or projector. Select “Screen” or “All” to see a brief on-screen message or select “RS232” to be see messages via RS232 and RS422 serial communication only. To disable error message display, select “Off.”

IR and SERIAL SETUP MENU

Use the checkboxes and pull-down lists in the *IR and Serial Setup* menu to alter the methods or types of communication to and from the projector. Changes made to the *IR and Serial Setup* menu will be saved when you exit the menu.

IR and Serial Setup		
Baud Rate		9600 ▼
Front IR Receiver		A or B ▼
Back IR Receiver		A or B ▼

Installation Menu

Baud Rate

1200
2400
▶ 9600
19200
38400
57600
115200

The baud rate setting determines the speed of communications to and from the projector. By default, the projector baud rate is set to 9600. Setting the correct speed is important when you are controlling the projector with an external device or another projector via an RS-232 or RS-422 port. You must set the projector baud rate at these ports to match the baud rate of the controlling device. If you are unsure about what baud rate to choose, refer to the documentation for the controlling device.

NOTE: 1) The baud rate setting does not affect the switcher port, which is always 9600 baud.

Front IR Receiver / Back IR Receiver

As described in *Section 2*, the standard IR remote keypad is capable of sending data to the projector in either one of two protocols called **A** or **B**. Likewise, the front and rear IR sensors on the projector can be set to accept IR data accordingly, responding to **A**, **B** or both. The projector's **A** or **B** default is adequate for most single-projector installations. Select a specific protocol to prevent interference when you are controlling two projectors in the same area and want to work with one projector at a time.

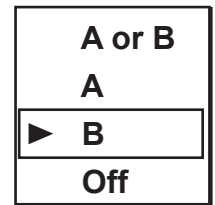

Note that the front and rear IR sensors cannot respond to *different* protocols-if you change a protocol for either sensor to anything other than **OFF**, the protocol for the other sensor also changes. For example, setting *Front IR Receiver* to **B** also changes the *Back IR Receiver* to **B**. If you want only *one* sensor to respond to a particular protocol- **A**, **B**, or **A** or **B**-disable the other sensor by setting its protocol to **OFF**.

If you want to disable *both* IR sensors, you cannot use the IR remote keypad to select the second **OFF** setting. This safeguard prevents accidentally disabling a keypad while you are using it. Instead, use either the built-in keypad or the wired remote to set the remaining active sensor to **OFF**. The projector will no longer respond to an IR remote keypad.

IMPORTANT

Keep at “A OR B” unless you are sure of the current IR keypad protocol.

NOTES: 1) The IR remote keypad for this projector is set at Runco to “Protocol A”. See 2.12 in Chapter 2, Keypad Protocols and Conversion for information about changing the keypad protocol. 2) A key press from a conflicting protocol will cause a single yellow flash on the Status LED located in the lower right corner of the rear projector panel.

Wired Keypad

Like the IR remote keypad, the optional wired keypad is either a “Protocol **A**” keypad (default) or a “Protocol **B**” keypad. Likewise, the projector can be set to accept wired keypad data accordingly, responding to **A** or **B**. If desired, you can prohibit the projector from responding to a particular wired keypad protocol, or you can ensure that the projector responds to either protocol (default). You can also prevent the projector from responding to the keypad entirely. In the pull-down list, select the desired protocol.

NOTE: The wired keypad for this projector is set at manufacture to “Protocol A”. See 2.12, Keypad Protocols and Conversion for information about changing the keypad protocol.

Adding a Protocol: To add a protocol, select the **A** or **B** option.

OPERATION

Changing a Protocol: As a safeguard, you cannot accidentally select an option in the “Wired Keypad” list that would disable the wired keypad during use, since such options are automatically disabled in the list. In other words, you cannot switch to the opposite protocol or select OFF using the wired keypad. Instead, if you want to quickly change to the other protocol, you may find it more convenient to use one of the other keypads (the built-in keypad or the IR remote) to execute the protocol change for the wired keypad. The projector will now recognize only the opposing change for the wired keypad protocol. Or, if you prefer, use the wired keypad to safely change its own protocol:

1. Select the **A** or **B** option. This will ensure that once your keypad is manually changed (see Step 2), it will still be recognized by the projector.
2. Unplug the keypad and change the protocol in the keypad as desired. Do this either by entering the short-cut software command or by hard-wiring the keypad as described in 2.12, *Keypad Protocols and Conversion*.
3. Plug the keypad back into the projector. Return to the IR and *Serial Setup* menu and select the new protocol you have just set up in the wired keypad.

Turning off the wired keypad: If you want to disable the wired keypad entirely, you cannot use it to select the **OFF** option. This safeguard prevents you from accidentally disabling the wired keypad during use. Instead, use either the built-in keypad or the IR remote keypad to select **OFF**. The projector will no longer respond to the wired keypad.

TEST PATTERNS

Use to select various test patterns.



Test Pattern Menu

OSD LANGUAGE

This projector displays menu and help text in English only.

DISPLAY MEMORY BANK LIST

Enter a checkmark if you want to see a scrollable channel list whenever you press Chan from your presentation (note that each channel to be included in the list must also be tagged in the “In Menu” checkbox in the *Memory Banks* menu). This option also enables on-screen feedback when using the Input key. If you prefer to hide the channel list and input dialog box while switching channels and sources during a presentation, do not enter a checkmark.

NOTE: The Bank List and input dialog box cannot be hidden when a menu is displayed.

Video Termination

Enter a checkmark to terminate the video inputs 3 and 4 (75W). The input should be terminated unless the signal loops through (continues) to another projector or display device, in which case only the last projector in the chain should be terminated.

<input checked="" type="checkbox"/>	* For all single free-standing projectors * For last projector in a network
<input type="checkbox"/>	* For all networked projectors except the last one

Menu Options

In this submenu, choose the default location desired for on-screen menus. You can use the shift options to move a location up or down, creating a Custom location. Note that menus for this projector often expand and can be quite large - avoid placing them too low or too far to the right where they may be cropped.

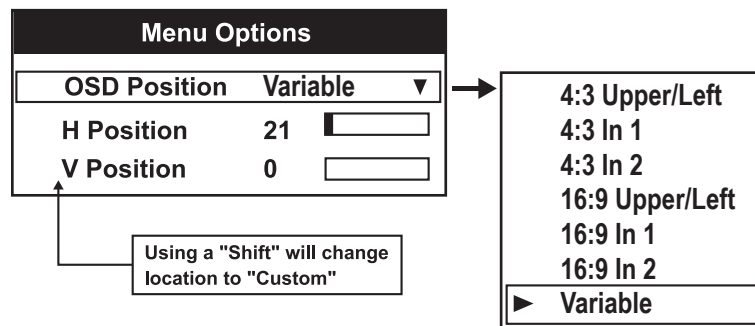

Submenu for Menu Options

OPERATION

INSTALLATION MENU

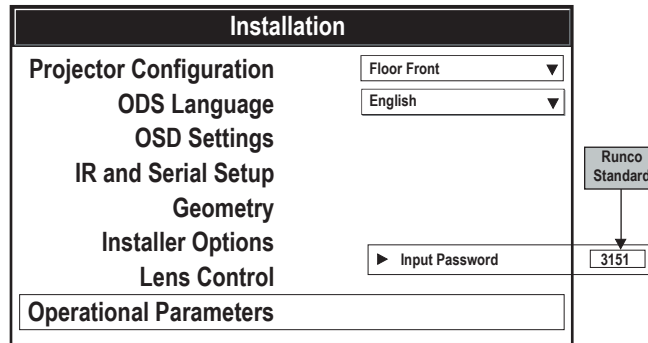

Projector Configuration allows the mounting configuration of the projector to be changed between ceiling/floor and front/rear configurations.

English is the only OSD language used in the VX-4c and VX-6c chassis.

OSD settings allows for changing the placement of the OSD. See page 3-24 for further information on how to use this function.

IR and Serial setup allows the installer to change the IR configuration of the projector and also the baud rate of the projector. To use the control link from the VIVIX processor to control the projector, please set the RS-232 baud rate to 9600 for proper operation.

Test Patterns allows for direct access to the internal test patterns. Please see page 3-29 for a full list of internal patterns.

Installer Options requires the installer to enter a password. The default password is 3151 and can be changed in the Operational Parameters menu to a custom password.

Lens Control is only available when the VX-4c / VX-6c is equipped with optional motorized lens movement. There are options for setting the H/V shift and zoom/focus of the lens assembly.

INSTALLER OPTIONS

Use the "Installer Options" submenu to select a test pattern or to freeze the current image, both helpful for closely examining performance. You can also turn specific colors on or off to further pinpoint where a suspected problem may be occurring.

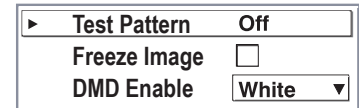

Test Patterns

Use the pull-down list to select and display an internal test pattern. Select OFF to turn off the display of a test pattern.

NOTE: For quicker access from your presentation, use the key to cycle through the patterns. At the last pattern, press to return to your presentation-or press at any time.

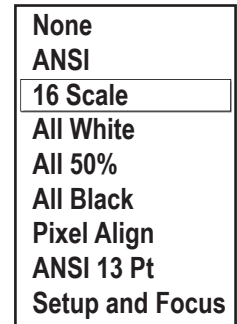

Freeze Image - Use the "Freeze Image" checkbox to freeze (stop) the image at a single frame. This diagnostic tool is useful if you need to examine in detail a still version of the incoming image that may not be "freezable" at the source. For example, in moving images it is difficult to observe artifacts such as external deinterlacing/resizing and signal noise.

DMD Enable

Select which color or colors you want to see, set to G DMD for focusing the projector.

NOTES: 1) Input levels apply for the current source only, but for any color temperature used. 2) Assuming that color temperature has been set up based on the internal test patterns, you can then set up input levels for a given source so that it matches the color temperature of the internal test patterns.

OPERATION

DMD Odd Pixel

NOTE: For sources with Color Balance set to RGB only.

When using certain RGB sources with static images, you may need to adjust the normal gain or offset of odd pixels in relation to even in order to smooth out very narrow (1-pixel wide) checks or vertical stripes. These patterns signify adjacent “on” and “off” pixels, and can be removed as follows:

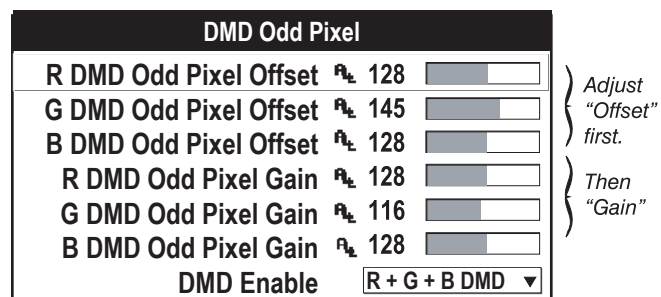

DMD Odd Pixel Menu

1. Use an external grayscale test pattern of some kind (make sure it has both dark grays and light grays).
2. Make sure the image is displayed in its native resolution, i.e. with **No Resizing**.
3. Display a single color - choose through the “DMD Enable” menu option or use the key shortcuts shown on the back of the remote keypad.
4. Examine an area of **darkest** gray (but not black). If there is a 1-pixel wide pattern present, adjust “DMD Odd Pixel” **offset** for the current color. Stop when the pattern disappears and the area is smooth.
5. Examine an area of **lightest** gray (but not white). If there is a 1-pixel wide pattern present, adjust “DMD Odd Pixel” **gain** for the current color. Stop when the pattern disappears and the area is smooth.
6. Repeat for each color, adjusting offset then gain for each.

NOTES: 1) Always adjust offset before gain, since offset affects gain. 2) A value of 128 represents no change in normal odd pixel offset or gain. 3) DMD Odd Buffer eliminates “1 pixel on, 1 pixel off” patterns only, not any type of larger patterns.

Advanced Color Temperature

Select the *Advanced* “Color Temp” option if you want to apply, alter, add, or copy a color temperature, or if you want to use an unaltered factory default color temperature.

By default, the projector can utilize any of four calibrated factory-set color temperatures: 3200, 5400, 6500 or 9300 (expressed in degrees Kelvin). For most applications, these temperatures will display accurate and realistic colors from a variety of sources. They can be selected at any time in either the *Image Adjustments* menu or in the *Advanced Color Temperature* menu.

OPERATIONAL PARAMETERS

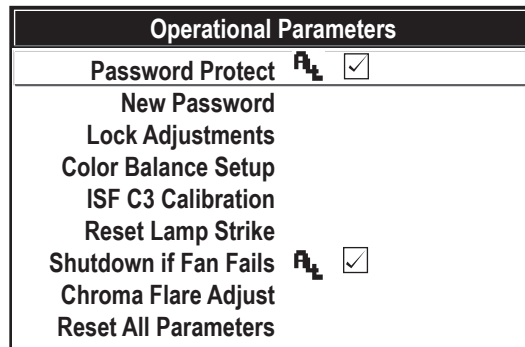

Operational Parameters Menu

Password Protect

In Operational Parameters the installer can decide to use password protection by putting check in the box to the right of the Password Protect item.

New Password

A New Password can be established by selecting the new password item from the menu.

Lock Adjustments

The Lock Adjustments item brings up another sub menu of each type of adjustment that can be locked globally, such as color, tint, contrast, etc.

Color Balance Setup

In Color Balance Setup, the preset color balance for the ISF DAY and ISF NIGHT presets can be customized and stored.

ISF C3 Calibration

The ISF 3C splash screen can be configured in the ISF 3C Calibration sub menu. This allows the installer to enter the customer's name, installer's name, and date of calibration.

Reset Lamp Strike

Reset Calibration Counter allows the installer to zero out the calibration counter that appears in the information screen. This should be done each time the projector is calibrated. This counter is separate from the lamp hours and projector hours, it is used to record the time between subsequent calibrations to the projector.

Shutdown If Fan Fails

The Shutdown if Fan Fails should always be checked to in order to not void the warranty.

Chroma Flare Adjust

The Chroma Flare Adjust is used as a convergence function to correct for large chromatic errors may occur on screen sizes above 20' wide.

Reset All Parameters

Reset All Parameters puts the projector back to the factory default state. All calibration data is lost and the projector must be setup from the beginning.

OPERATION

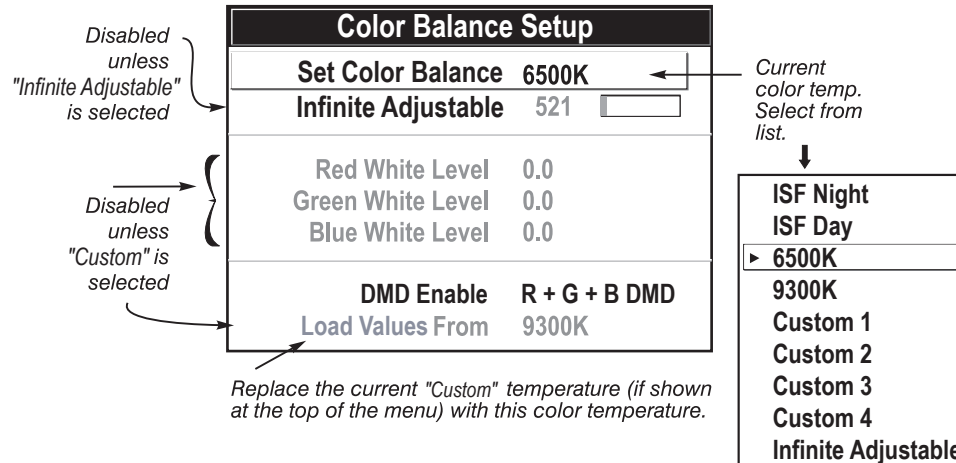

Color Balance Setup Menu

However, if you require extra color temperatures, you can also add up to five custom color temperatures - four "Custom" and one "Infinite Adjustable"-by defining them within the *Color Balance Setup* menu (each defaults to 6500K until then). Any "Custom" or "Infinite Adjustable" temperature created here is immediately applied, or it can be selected at any time from the Image Adjustments menu as usual, regardless of your source or channel. The *Color Balance Setup* menu options are described below.

NOTE: For best results, use an internal grayscale test pattern when working with color balance.

SET COLOR BALANCE - See *Color Balance Setup Menu* above. Upon opening the *Color Balance Setup* menu, the current temperature appears as the top option. You can change to a different color temperature here as desired, just as in the *Image Adjustments* menu. Note that if you select a "Custom" color temperature, the "White Level" options further down in the *Color Balance Setup* menu are no longer disabled-you can adjust them as desired to define or change a "Custom" color temperature (see "White Levels", below). Likewise, selecting "Infinite Adjustable" here activates the "Infinite Adjustable" sidebar for defining or changing color temperature.

INFINITE ADJUSTABLE - Select this option if you need a specific color temperature that lies somewhere between one preset color temperature and another. Adjust the sidebar to define a new temperature that will be adjusted from the neighboring presets (for example, 7841 is interpolated from 6500 and 9300). It can be used any time and appears as a 4-digit temperature when present.

WHITE LEVELS -These 3 controls are adjustable only if a "Custom" choice is selected (in which case "Custom 1, 2, 3 or 4" appears at the top of the *Color Balance Setup* menu). Their current values are shown for the active color temperature. Changing a white level here changes the drive (contrast) for that color, essentially creating a new color temperature that is "warmer" or "cooler" etc. When you are satisfied with the new "Custom" temperature, it can be used immediately upon exit or it can be selected from either the *Image Adjustments* menu or the *Color Balance Setup* menu as usual. You can re-define a "Custom" color temperature at any time using the *Color Balance Setup* menu.

DMD ENABLE - Select which color or colors you want to see, useful while working with color temperature white levels.

LOAD VALUES FROM - Use this option to replace the currently selected "Custom" color temperature setup with that of another. This function can be particularly useful for creating a starting point for a new "Custom" color or for accessing an unaltered factory default. It is disabled for all color temperatures *except* "Custom". See "Load Values From" below.

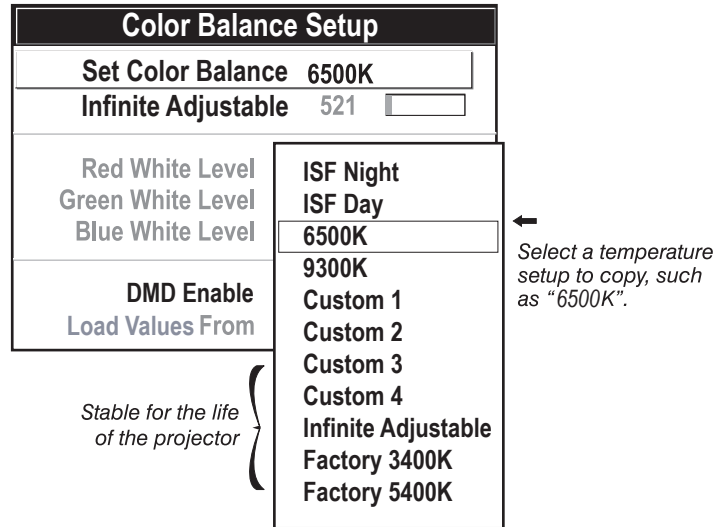

"Load Values From"

To create a starting point: To set a starting point for a new custom user color temperature, select a user temperature, then highlight "Load Values From" and select a temperature that is similar to what you want. Adjust white levels from there as desired.

To use a factory default: The preset color temperature setups (3200K, 5400K, 6500K and 9300K) can be altered from within the password-protected Service menu only-note that although such an alteration changes the *setup and appearance* for a preset, it does not change its *name*. If you suspect that you are using a preset temperature that has been altered and you want instead to use the original calibrated factory color temperature without clearing the entire projector memory, you can use the "Load Values From" option in the *Color Balance Setup* menu to set up a "Custom" temperature with settings from a permanent factory preset:

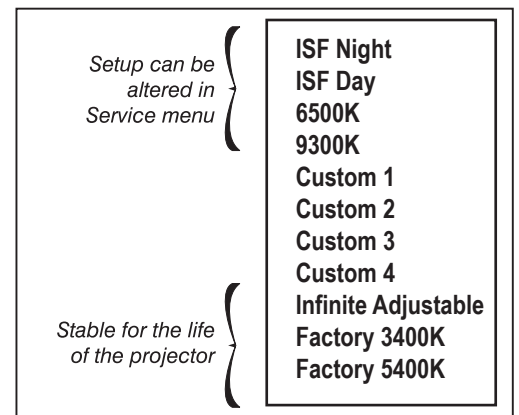

Presets and "Factory"Presets





1. Enter the "Custom" color temperature you wish to update at the top of the *Color Balance Setup* menu, such as "Custom 2".
2. From the "Load Values From" list, select the matching temperature labeled "Factory" (such as "Factory 5400K").
3. The setups for the "Custom" color temperature you entered at the top of the *Color Balance Setup* menu will now be updated/replaced by those for the permanent factory calibrated temperature you selected in the "Load Values From" list. Again, a "Custom" temperature can be altered at any time, if desired.

OPERATION

LAMP ADJUST

Whenever you install a new lamp in the projector you need to access the Lamp Adjust submenu and record the lamp serial number in the projector's memory. You can also set different Lamp submenu options such as intensity (output) or power required. These setups can be changed at any time.

NOTE: See 2.2, Installing The Lens for complete instructions on installing a new lamp in the projector.

Lamp Adjust	
Xenon Lamp Hours	015
New Xenon Lamp Serial No.	2LJa869
Lamp Message 	<input checked="" type="checkbox"/>
Xenon Lamp Limit 	1000 <input type="text"/>
Xenon Lamp Mode 	Max Output <input type="text"/>
Constant Power 	1000 <input type="text"/>
Constant Intensity 	4114 <input type="text"/>
Xenon Lamp History	
Replace Xenon Lamp	

Lamp Adjust submenu

From the Advanced menu, select the "Lamp Adjust" option for access to the *Lamp Adjust* submenu, where all lamp functions and data appear. Read-only information includes the number of hours logged on the lamp so far and the serial number recorded for the installed lamp.

XENON LAMP HOURS shows the number of hours logged on the current lamp. Whenever you record a new lamp serial number, this value automatically resets to "0", where it begins to log time for the new lamp. *Note: Read-only.* This information also appears in the *Information* menu.

New XENON Lamp Serial No. is the serial number recorded for the current lamp. When you install a new lamp and enter its serial number, the number will appear here in the *Xenon Adjust* menu. *Note: Read-only.*

Enter a checkmark for **LAMP MESSAGE** if you want to enable a warning message upon power-up that the lamp has reached the specified lamp limit and should be replaced. Delete the checkmark if you do not want to see this warning-instead, when your lamp expires, only the status information on the back of the projector will provide the warning to replace the lamp.

NOTES: 1) It is recommended that the Lamp Message checkbox remain enabled. 2) When a lamp warning message appears, press  to temporarily cancel the message. The message will continue to appear upon power-up until you install a new lamp.

Set **XENON LAMP LIMIT** to the number of hours you expect to log on the current lamp before replacing it. The recommended limit is 1000 hours. At lower power settings, 2000 hours is possible.

NOTE: 1) If you change modes over the life of a lamp, the lamp limit you originally expected may no longer be possible. **2)** Turning the lamp on and off reduces lamp life significantly, as do other factors.

Set which **XENON LAMP MODE** you want to use in order to control the light output. Although there are exceptions, in most lamps, the higher the light output or power setting, the shorter the life span of the lamp.

<input type="text" value="Max Output"/>
Constant Intensity
Constant Power

Use the lamp mode that best suits your brightness needs. For example, in a tiled application you may want to precisely match brightness levels between adjacent images-choose Intensity for each projector, then judge by eye and set each individual intensity setting as necessary (see "**Constant Intensity**", below). Or you may simply always need as much brightness as possible-choose **Max Output**.

Lamp modes are described below:

- **Max Output:** The lamp will always burn as brightly as possible, driven by maximum power of 700W (VX-4c) and 1200W (VX-6c). Keep in mind that the "maximum brightness" for any lamp gradually diminishes with age - the image will become dimmer over time. Its current output level appears in the "**Constant Intensity**" option (not in lumens).
- **Constant Intensity:** Brightness will remain at a specified level for as long as possible. Once you select this option, enter a number representing the intensity level (brightness) you wish to maintain. Note this value is a correlation only (0-9999), not actual lumen levels possible (0-3000, e.g.). See "**Constant Intensity**" below.
- **Constant Power:** The power supplied to the lamp will remain at a desired watt level throughout the life of the lamp. Once you select this option, enter the number of watts representing the power level you wish to maintain. See "**Constant Power**" below.

CONSTANT POWER: The number shown here indicates how many watts are applied to the lamp. Set from 450-700W (VX-4c) and 800-1200W (VX-6c) as desired, keeping in mind that lower power levels produce dimmer images. When in "**Constant Power**" or **Max Output** modes, the power level remains constant. When in "**Constant Intensity**" mode, the power level will change as necessary. Specifying a power level of 700 is the same as operating in **Max Output** mode.

NOTES: 1) Power level can be set only if the lamp is in "constant power" mode. 2) If you are in "Intensity" mode, the power level value will automatically increase over time as necessary to maintain the desired brightness, until power reaches 700W.

CONSTANT INTENSITY: This number is a representation of the current brightness of your lamp, decreasing over time when you are operating at **Max Output** or at a specific **Power** level. However, when you are operating in "**Constant Intensity**" mode, this value remains at the original "**IN**" setting chosen.

NOTE: The number shown for "constant intensity" is not the actual lumen output, but rather a correlated value only-9999 may represent 3000 lumens, for example.

To use "**Constant Intensity**" mode, judge by eye and set the level as desired for your application, remembering that higher settings can significantly shorten lamp life. Over time, the projector will automatically increase the power supplied to the lamp as needed to maintain the chosen intensity to within 5% of the setting. This is called "brightness tracking".

OPERATION

Keep in mind that once the lamp power has reached its *maximum* of 700 watts (see "**Constant Power**", above), this tracking is no longer possible. At this point, the lamp will gradually begin to dim as usual, even though your original "**Intensity**" value will still appear in the menu. To resume accurate tracking, reduce the intensity setting so that the resulting "**Power**" value is under 700 watts (VX-4c) and 1200W (VX-6c) - the lower the intensity, the longer it can be maintained.

Do not lower the "**Intensity**" so much that the corresponding "**Power**" value reaches its minimum of 450 watts (VX-4c) and 800W (VX-6c) - the intensity setting will be inaccurate and cannot be maintained.

NOTES: 1) Lamps become more stable over time, thus a specific intensity is more easily maintained as the lamp ages 2) Intensity can be set only if the lamp is in "Intensity" mode 3) Intensity cannot exceed the output of Max Brightness mode.

XENON LAMP HISTORY - This read-only option lists the most lamps most recently installed and recorded in the projector. Lamp History automatically updates whenever you record a new lamp serial number-the new lamp is added to the bottom of the list.

Xenon Lamp History	
Serial No.	Hours
1 2LJa869	015

Use **CHANGE LAMP** to record the serial number for a newly installed lamp.

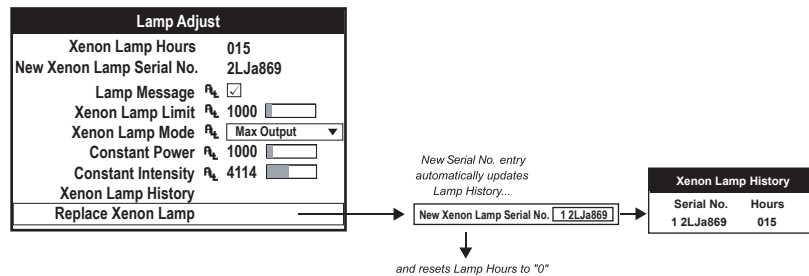

Recording the New Lamp Serial Number

In the *New Xenon Lamp S/N* window, use the number text entry keys to record the new lamp serial number, and press **Enter** again to accept the change. See *Using Slidebars and Other Controls* if you need help entering the number. Once entered, the new lamp serial number will be added to the *Xenon Lamp History* menu and the *Lamp Hours* timer will reset to "0". *Xenon Lamp Mode* and *Lamp Limit* remain as they were for the previous lamp, and can be changed at any time.

*NOTE: Enter a serial number **only** if you have just installed a new lamp. This will help ensure that lamp timer is not reset on an old lamp and that the number of hours logged on the lamp will be accurate.*



IMPORTANT



Always record the serial number of a NEW lamp.

Information			
Customer Name	J. Chan		Scroll to see more
Calibrator Name	Andy S.		
Date of Calibration	11/17/03		
Next Calibration	11/17/04		
Name	Runco VX-4c / VX-6c		
Serial No.	123456789		
Xenon Lamp Adjust	20	Calibration Counter	5
Projector Hours	152	Resolution	Hours logged for current period (reset in Operational Parameters)
Memory Bank Label		Sync Type	Tri-Level on HC input
Memory Bank No.	02	Sync	33.75 kHz + 60.00 Hz –
		Sample Rate	120Mhz
IPM	2.3	Software	1.0
Interconnect		Boot	
Panel Driver		Light Engine	
LCD HW		LCD SW	
Decoder			
ACM			

Information Menu (SAMPLE)

3.8 Error Conditions

Occasionally the projector may encounter an error condition that interrupts normal operation. Such a condition can be caused by an invalid user entry, an input signal error (most common) or other system error.

If you would like to be notified on-screen of such errors, select the "Screen" option from the "Display Error Messages" pull-down list (in *OSD Settings* menu). If you would like to be notified via a serial communication only, select the "RS-232" option instead. To receive both notifications, select "All". To disable error messages (except for invalid user entries), select "Off".

NOTE: Error messages also always appear at the rear LCD next to the keypad.

Invalid User Entry

Any keypad entry not recognized by the projector will trigger an on-screen error message describing the problem. For example, if you specify a channel number that has not been defined, the message "Invalid Channel" will appear. Or if you try to enter the wrong password, you'll see "Invalid Password". Press or to confirm the message and eliminate the message box.

*NOTE: Displaying of "Invalid User Entry" messages cannot be disabled, even if **Display Error Messages** has been set to "Off".*

Input Signal Error

Input signal errors messages appear when there are no menus present, and have selected an input on which the projector detects a problem. While menus remain operational and pressing any key will temporarily remove the message from the screen, you must resolve the signal problem in order to permanently eliminate the message.

*NOTE: Input signal messages appear on-screen only if **Display Error Messages** has been set to "Screen" or "All".*

OPERATION

No Signal

The message "*No signal*" appears when there is no signal detected at the selected input. Both HSYNC and VSYNC are inactive and the screen background is black. Connect or correct the signal, or select another input.

On the IR remote or wired keypad, press **0** to display the projector box. Press again without entering a number - the keypad commands will now affect all projectors.

Make certain that only one projector has its "Broadcast Keys" option selected (checked) - the remaining projectors should have the option unchecked and their keypads disabled (do this in Preferences menu). The "Broadcast Keys" projector will then relay keypad commands to the others. If using a wired remote, make sure to select the "Broadcast Keys" option for the projector to which the wired remote is connected.

NOTE: If you are using a computer or controller to issue commands, use the correct RS-232 software command to broadcast.

Bad Sync

The message "Bad Sync" is displayed when HSYNC or VSYNC are active but the signal cannot be displayed. Such a condition occurs when only one of the two signals is present, or when either signal is unstable or of the wrong frequency. Correct the signal or select another input.

Other Signal Error Messages

In addition to the common "*Bad Sync*" and "*No Signal*" errors, you may encounter a signal error message indicating that Hsync and/or Vsync are either too fast or too slow. When such a message appears, check the frequencies shown in the Information menu. If they are correct, then the signal may be out of the projector's operating range. On some PCs you may be able to change the settings to generate a compatible signal. If the frequencies shown in the Information menu are incorrect, check the cabling to see where the problem is.

System Warnings / Errors

When the projector encounters a system malfunction, either a System Warning message or a System Error message may appear. Both types of messages are accompanied by a steady red "Power" LED and a flashing red-and-yellow error code on the "Status" LED. This condition indicates the need for service by a qualified Runco service technician.

*NOTE: System messages appear on-screen only if **Display Error Messages** has been set to "Screen" or "All".*

System Warnings

A system *warning* message indicates that a system malfunction has been detected (see *Status LED Codes*, below). A system warning message replaces any input signal message and disappears when the input signal status changes. While the projector will remain operational, the message indicates the presence of a serious problem that should be reported to the manufacturer. You can press to remove the message, but for best results you should reset the projector-power the projector down and up again with the key.

System Errors

A system *error* message indicates that a serious malfunction has been detected and must be reported to the manufacturer (see *Status LED Codes*, below). The projector will no longer operate and must be reset-power the projector down and up again with the key.

The Status LED Codes

If the "Status" LED on the back of the projector repeatedly flashes a pattern of yellow and red light while the "Power" LED glows a continuous red, you have encountered a likely system error requiring the attention of a qualified service technician (see *System Warnings and System Errors*, above). Try resetting the projector by powering it off and on again, cooling when necessary. Consult Table 1 and contact your Runco Dealer if the problem persists.

The specific pattern of flashing indicates the 2-digit code identifying the type of problem encountered-the number of yellow flashes represents the first digit and the number of red flashes indicates the second digit. For example, a pattern of "yellow-yellow-red-red-red" is "Code 23", meaning the lamp ballast (power supply) is overheated. These codes include (see next page):

OPERATION

Table 1. System Error Codes

Code	Description
GENERAL	
12	Software bug
13	CRC error in flash ROM
14	Programming complete
15	Attempting to download code without being in boot mode
16	Invalid interrupt
LAMP / BALLAST	
21	Unable to turn the lamp on
22	Lamp is overheated
23	Lamp ballast (power supply) is overheated
24	One or more of the lamp interlocks are open
25	Lamp may be on before being turned on
26	Invalid lamp ballast ID
27	Unexpected lamp shut-off
IMAGE PROCESSOR MODULE	
31	Boot code CRC failed
32	Unable to program the Sync Xilinx part
33	Unable to program a device on Altera programming bus
34	Unable to program a device on JTAG programming bus
35	Unrecognized ROM type
36	Write to flash ROM failed
37	General IPM failure
38	Code being downloaded will not fit in ROMs
PANEL DRIVER MODULE / LIGHT ENGINE ELECTRONICS	
41	Unrecognized Panel Driver Module (PDM)
42	Unable to program a device on Panel Driver programming bus
43	Panel Driver/light engine communication problem
44	Red Formatter/flex cable problem
45	Green Formatter/flex cable problem
46	Blue Formatter/flex cable problem
POWER & COOLING	
51	Fan #1 failed (part of Cooling Module)
52	Fan #2 failed (part of Cooling Module)
53	Fan #3 failed (side fan, rear—connects to J38 on ICM)
54	Fan #4 failed (side fan, front—connects to J39 on ICM)
55	Low voltage power supply failed to turn on
MOTOR CONTROL MODULE (not in the VX-3b)	
61	Problem communicating with MCM
INTERCONNECT OR CHASSIS I.D.	
71	Unable to access EEPROM on the ICM
72	EEPROM memory has re-initialized
VIDEO DECODER MODULE (INPUT 3 OR 4)	
81	Unable to program the video decoder (VDM)
OPTIONAL INTERFACE MODULE	
91	Unable to program the option card

If you encounter a system error, try resetting the projector by powering it off and on again (cooling if necessary).

Maintenance

4.1 Warnings and Guidelines

This projector is CSA approved and is designed for safe and reliable operation. However, safe operation cannot be assured by design alone; installers, maintainers, and users must maintain a safe operating environment for the system. Please read through and understand the following warnings and guidelines promoting safe usage of the projector.



**Never look directly into the projector lens.
The extremely high brightness of this projector
can cause permanent eye damage.**



**For protection from ultraviolet radiation,
keep all projector shielding intact during operation.**

Labels and Markings

Observe and follow all warnings and instructions marked on the projector.

The exclamation point within the equilateral triangle alerts the user to important operating and maintenance (servicing) instructions in the literature accompanying the projector.



The lightning flash and arrowhead symbol within the equilateral triangle alerts the user to non-insulated "dangerous voltage" within the projector's enclosure that may be of sufficient magnitude to constitute a risk of electric shock.



Projector Location

Operate the projector in an environment that meets the operating range specifications in *Section 5, Specifications*. Do not operate the projector close to water, such as near a swimming pool.

Do not place the projector on an unstable cart, stand or table. If the projector is to be ceiling mounted, only use a Runco-approved ceiling mount fixture.

A projector and cart combination should be used with care. Sudden stops, excessive force, and uneven surfaces may cause the projector and cart combination to overturn.



MAINTENANCE

Lamp and Filter Replacement

LAMP: Do not operate the Xenon lamp for more than 1000 hours; risk of the lamp shattering increases as a result of changes in the quartz glass. Also, operation beyond 1000 hours significantly reduces brightness output.



**Never attempt to remove the lamp housing directly after use.
The lamp is under great pressure when hot and may explode,
causing personal injury and/or property damage.
Allow to cool completely.**

The arc lamp operates at a very high temperature and pressure. Failure to allow the lamp to sufficiently cool prior to handling could result in an explosion causing personal injury and/or property damage. After turning the projector off it is important that you wait at least five minutes before unplugging it. This provides enough time for the internal lamp cooling fans to cool the lamp and to automatically shut off. Cool completely before handling.



Use only lamps supplied by Runco.

FILTER: Replace the side filter every 1000 hours or sooner. If this filter is not replaced, air flow may become restricted and cause the projector to overheat.

See 2.2, *Replacing the Lamp and Filter* for the complete replacement procedure.



Use only filters supplied by Runco.

Power Cord and Attachments

Only use attachments or accessories recommended by Runco, such as the 13 amp high-current rated power cord supplied. Use of other attachments or accessories with this projector may result in the risk of fire, shock or personal injury.



**Use only the AC power cord supplied.
Do not attempt operation if the AC supply and
cord are not within the specified voltage and power range.**

Do not allow anything to rest on the power cord. Locate the projector where the cord cannot be damaged by persons walking on it or objects rolling over it.

Operate the projector at the specified voltage only. Do not overload power outlets and extension cords as this can result in fire or shock hazards. Runco recommends a dedicated AC circuit for the projector itself.

The projector is equipped with a three wire plug having a third (grounding) prong. This is a safety feature. If you are unable to insert the plug into the outlet, contact an electrician to have the outlet replaced. Do not defeat the safety purpose of the grounding-type plug.

Ventilation

Before unplugging the power cord, make sure the internal lamp cooling fans have shut off. The fans automatically shut off when the projector has adequately cooled down.

Slots and openings in the projector provide ventilation. To ensure reliable operation of the projector and to prevent overheating, these openings must never be blocked or covered. The projector should never be placed near or over a radiator or heat register. The projector should not be placed in an enclosure unless proper ventilation is provided.

Do not push objects of any kind into the projector through the ventilation openings. They may touch dangerous voltages or short-out components resulting in a fire or shock hazard. Do not spill liquids of any kind into the projector. Should an accidental spill occur, immediately unplug the projector and have it serviced by a qualified Runco service technician.

Servicing

If any of the following conditions exist, unplug the projector from the power outlet and refer service to qualified Runco service personnel.

- The power cord has been damaged.
- The internal cooling fans do not come on when the projector is first turned on.
- Liquid has been spilled into the projector.
- The projector has been exposed to excessive moisture.
- The projector does not operate normally.
- The projector has been dropped or the case has been damaged.

Do not attempt to service the projector yourself. All servicing must be performed by a qualified Runco service technician. If replacement parts are required, it is important that only Runco-approved parts are used. Other parts may result in fire, electric shock or risk of personal injury.

4.2 Cleaning

Clean the projector when required. Before cleaning, always unplug the projector from the power outlet.

Lens

To avoid the risk of scratching the lens, clean the lens *only* if absolutely required. A small amount of dust on the lens will have very little effect on picture quality. If the lens must be cleaned, use a DRY soft cotton cloth. Clean gently in a circular motion.

Lamp

It is important to never touch the glass surface of the lamp, as the oil imprint will seriously degrade lamp performance. Should you accidentally touch the surface of the lamp, clean carefully with a lint-free cloth moistened with isopropyl alcohol.

MAINTENANCE

Case

Clean the case with a soft dampened cloth. Use a mild commercial cleaner. Do not use liquid or aerosol cleaners.

4.3 Replacing Keypad Batteries

The optional IR Remote Keypad uses four AA size, 1.5V batteries (preferably alkaline). To install new batteries, open the battery compartment at the back side of the keypad by pulling on the raised portion of the cover as shown below.

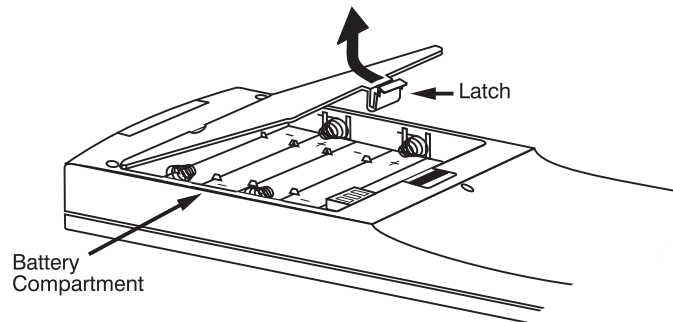

Replacing Keypad Batteries

Remove the old batteries and properly discard. Wait a minute or two and place the new batteries in the compartment, orienting the positive/negative of each battery according to the labels in the compartment. When batteries are in place, replace the cover by inserting its bottom edge first and snapping the top into place. Do not force.

NOTE: Always wait a minute or two when replacing batteries so that the internal electronics discharge and can recognize the change.

NOTE: For this procedure you will need a VX-4c/VX-6c Lamp and Filter Replacement Kit from Runco.

The high brightness of your projector is provided by a 700 watt Xenon lamp permanently mounted inside its own protective housing. When the bulb approaches 1000 hours of usage, this lamp assembly should be replaced.

How Old is The Lamp?

The number of hours logged on the current lamp appears both in the *Lamp Adjust* submenu (accessed through the *Advanced* menu) and the *Information* menu. In the *Information* menu, do not confuse “Xenon Lamp Hours” with “Projector Hours”, which indicates the number of hours logged during the ‘rental period’, in a situation where the VX-4c/VX-6c is to be rented for various functions. In a permanent install, this would be of no consequence.

*NOTE: As the lamp nears its limit (as set in **Lamp Limit**), a message can appear on screen to warn that the lamp needs to be replaced. To make sure that this warning appears, enter a checkmark in the **Lamp Message** checkbox located in the **Lamp Adjust** submenu.*

4.5 Troubleshooting

If the projector appears not to be operating properly, note the symptoms present and use the following guide to assist you. If you cannot resolve the problems yourself, contact your Runco dealer for assistance.

NOTE: Always check the LCD status window at the rear of the projector for initial information about a problem.

Symptom ►► The projector will not turn on when **Power** is pressed...

CAUSE / REMEDY:

1. Make sure to hold **Power** for approximately one second. Or press quickly and release, and follow with **▲ON**.
2. Do both LEDs come on at the rear of the projector? Check that the power cord is properly connected at the wall outlet (100-240 VAC, 50-60 Hz nominal) and that you are using the original high-current 13A cable provided.
3. Does the green “Status” LED flash with each key press? If not, the projector is not receiving the keypad’s IR signals. Ensure the keypad is directed at either the front or rear of the projector, or at the screen. Also make sure that these paths are not blocked. Try the built-in keypad.
4. The batteries in the IR remote keypad may be weak. Refer to page 2-17, *Replacing Keypad Batteries* for instructions.
5. The IR keypad may have been disabled by a change in protocol. See 2.12, *Keypad Protocols and Conversion* and 3.7, *Adjusting System Parameters and Advanced Controls*.
6. Use the **Power** key on the built-in keypad to turn the projector on.

Symptom ►► The projector is on but I can’t see display of source input...

CAUSE / REMEDY:

1. Was the lens cover accidentally left on? Remove lens cover.
2. Is the shutter closed? Is the projector in standby? Press **Exit** to clear.
3. Is an active source connected properly? Check the cable connections. And is the correct source selected? Press **Input1**, **Input2**, **Input3**, or **Input4** to select. See 2.10, *Source Connections* and 3.13, *Using Inputs and Channels* for details.
4. Are there test patterns or menus present? If so, check your source connections again.
5. The room lighting may be too bright. Lower the intensity of the room lighting. Reduce light reflections as much as possible.
6. Increase contrast and/or brightness of image.
7. The projector may be too far from the screen. Move the projector closer.
8. Is the “Status” LED flashing a pattern of yellow and red lights while the “Power” LED is steady red? This indicates an internal system error that may prevent the projector from operating. If the problem persists contact a qualified Runco service technician.

MAINTENANCE

Symptom ►► The projector does not respond to the infrared remote keypad...

CAUSE / REMEDY:

1. Does the built-in keypad work? If so, check that the keypads are enabled.
2. Does the green “Status” LED flash each time a key is pressed? If not, the projector is not receiving the keypad’s IR signals. Ensure the keypad is directed to either the front or rear of the projector, or towards the screen.
3. The viewing path between the IR keypad and the projector (or screen) may be blocked. Ensure there is a clear line-of-sight between the keypad and the projector (or screen).
4. The batteries in the IR remote keypad may be weak. Refer to page 2-17, Replacing Keypad Batteries for instructions on how to replace the batteries.
5. There may be unusual lighting conditions in the room affecting IR keypad operation. Determine if such conditions exist and correct.
6. The IR keypad may have been disabled for use with this projector(s). Press to enable broadcasting to all projectors. See 2.12, Keypad Protocols and Conversion and 3.7, Adjusting and Checking System Parameters for additional information.

Symptom ►► The power is on but the lamp is not...

CAUSE / REMEDY:

1. Does the LCD status window say “warming up”?
2. The projector probably became overheated (there is likely an error code flashing and a message in the LCD status window). Allow to cool and make sure that nothing blocks projector vents. Do not operate in environments warmer than 35°C (95°F).
3. The lamp may have reached the end of its life. Check the “Lamp Hours” via RS-232 request ‘lph?’.

Symptom ►► The display is jittery or unstable...

CAUSE / REMEDY:

1. If the display is jittery or if it disappears and reappears erratically, check that the source is properly connected and that its signal is of adequate quality for detection. For example, if the projector scans the default input for a signal to display, and a poor quality or improperly connected source is connected, the projector will briefly and repeatedly attempt to display an image. If no source is connected, the “No signal present” error message appears over a blank display. Correct the source connection.
2. The horizontal or vertical scan frequency of the input signal may be out of range of the projector. Refer to page 5-1, Specifications for scan frequency ranges.
3. The sync signal may be inadequate. Correct the source problem.
4. The input signal type may conflict with the input module. Install/use the correct module for the source.
5. Pixel tracking, phase, filter, etc. may need more adjustment.

Symptom ►► The display is faint...

CAUSE / REMEDY:

1. Check Input Levels option—turn auto to “off”, then “on” again.
2. Brightness and/or contrast may be set too low. Adjust as necessary.
3. Gamma may be set too low. Recommended setting for most signals is 2.2.
4. The projection room may be too bright. Lower the intensity of projection room lighting and reduce light reflections as much as possible.
5. The projector may be too far from the screen. Move the projector closer.

6. The location of the audience with respect to the screen may not be ideal. Make sure the audience is within the viewing angle set by the projector and screen position, and the screen type.
7. The source may be double terminated. Ensure the source is terminated only once.
8. The source (if non-video) may need sync tip clamping. Enter a check in the "Clamp Tip" box found in the *Input Levels* submenu.

Symptom ▶▶ The display is reversed and/or upside-down...

CAUSE / REMEDY:

1. The projector's image orientation is not set correctly for the current installation. Refer to 2.6, *Operating Orientation* to set the projector's image orientation to match your installation.

Symptom ▶▶ The upper portion of the display is waving, tearing or jittering...

CAUSE / REMEDY:

1. This can sometimes occur with video or VCR sources. If you are using a VCR, make sure that the "VCR" option is checked (in *Advanced* menu).

Symptom ▶▶ Portions of the display are cut off or wrap to the opposite edge...

CAUSE / REMEDY:

1. Reduce top, bottom, left or right blanking from within the *Scaling Parameters* menu. Check size and position adjustments.
2. Resizing may need adjustment. Adjust until entire image is visible and centered.

Symptom ▶▶ The display appears compressed or stretched...

CAUSE / REMEDY:

1. The frequency of the pixel sampling clock is incorrect for the current source.
2. The *Scaling Parameters* options may be adjusted poorly for the incoming source signal. See 3.6, *Adjusting the Image*.

Symptom ▶▶ Display quality appears to drift from good to bad, bad to good...

CAUSE / REMEDY:

1. The operating temperature of the projector may be fluctuating. Watch that the projector is not located too close to heating/air conditioning vents.
2. The source input signal may be of low quality.
3. The horizontal or vertical frequency of the input may have changed at the source end.

Symptom ▶▶ The display has suddenly frozen, or an unknown menu has appeared...

CAUSE / REMEDY:

1. You may have accidentally entered a special engineering code using the key in combination with certain numbers, or you may have selected the "Freeze Image" option. Press as necessary to cancel the function and return to presentation level.
2. If the screen blacks out inexplicably, it is possible that excessive voltage noise on the AC or ground input has interrupted the projector's ability to lock on to a signal. Turn the projector off, wait for the lamp fans to stop, and unplug. Plug in again and power up as usual.

Symptom ▶▶ The display is not sharp or "clean"...

CAUSE / REMEDY:

1. More display adjustment may be required-focus, brightness, contrast, pixel tracking, pixel phase, and detail.
2. If you are using a BNC T-connector, try using a distribution amplifier to boost signal levels.
3. Is the video input signal properly terminated? Set in *OSD Settings* menu.
4. The screen size may be too large. As screen size increases, magnification increases, reducing brightness and clarity. See lens specifications in *Section 5*.
5. The source input signal may be of low quality. Try another source.

MAINTENANCE

Symptom ▶▶ Colors in the display are inaccurate...

CAUSE / REMEDY:

1. The color, tint, gamma, color space and/or color temperature settings may require adjustment. Review all settings, and refer to 3.6, *Adjusting the Image* and 3.7, *Adjusting System Parameters and Advanced Controls*.

Symptom ▶▶ The display is not rectangular...

CAUSE / REMEDY:

1. Check leveling of the projector. If necessary, try relocating the projector or screen so that the lens surface and screen are approximately parallel
2. Is the vertical offset set correctly? Adjust as necessary using the vertical offset knob on the front of the projector.
3. The "Vertical Stretch" option may need adjustment. Also check pixel tracking.

Symptom ▶▶ The display is "noisy"...

CAUSE / REMEDY:

1. Display adjustment may be required. Adjust pixel tracking, phase and filter.
2. The video input may not be terminated. Make sure the video input is terminated (75 Ω). If it is the last connection in a loop-through chain, the video input should be terminated at the *last* projector only.
3. The signal cables carrying the input signal may be of poor quality. Use only good quality signal cables.
4. The distance between the input source device and the projector may be too great. If the distance between the input source device and the projector is greater than 25 feet, signal amplification/conditioning may be required.
5. The input signal may be of poor quality.
6. If the source is a VCR or off-air broadcast, detail may be set too high. Keep near 4 for most sources.

Specifications

<u>Specifications:</u>	<u>VX-4c</u>	<u>VX-6c</u>
Projector Type:	Digital Light Processing™ (DLP™), 3-chip, 0.9”DMD™ - Dark Metal Process	Digital Light Processing™ (DLP™), 3-chip, 0.9” DMD™ — Dark Metal Process
Native Resolution:	1280 x 1024	1280 x 1024
Aspect Ratios:	Determined by supplied processor	Determined by supplied processor
Video Standards:	NTSC, PAL	NTSC, PAL
DTV Compatibility:	480p, 720p, 1080i, 1080p	480p, 720p, 1080i, 1080p
Scan Frequency:	Horizontal: 15-120 KHz Vertical: 24-120 Hz	Horizontal: 15–120 KHz Vertical: 24–120 Hz
Picture Size (16:9 Screen):	Recommended Width: 84-288 in. (16x9 screens) Maximum Width: 375 in.	Recommended Width: 84–360 in.(16:9 Screen): Maximum Width: 500 in.
Throw Distance:	Lens Option 1: Zoom 1.5 - 2.2 x Width Lens Option 2: Zoom 2.2 - 4 x Width Lens Option 3: Zoom 4 - 7 x Width Lens Option 4: Zoom 0.8 x Width (For rear screen applications) Anamorphic Cinema Lens Attachments: VX-4c @ 720p: None VX-4c @ 960p: 1.33 VX-4c @ 1024p: 1.42 VX-4c @ 1024p: 1.9, 2.35:1 w/2.35 Aspect Ratio: 1.9	Lens Option 1: Zoom 1.5 - 2.2 x Width Lens Option 2: Zoom 2.2 - 4 x Width Lens Option 3: Zoom 4 - 7 x Width Lens Option 4: 0.8 x Width (For rear-screen applications) Anamorphic Cinema Lens Attachments: VX-6c @ 720p: None VX-6c @ 960p: 1.33 VX-6c @ 1024p: 1.42 VX-6c @ 1024p: 1.9, 2.35:1 w/2.35 Aspect Ratio: 1.9
Horizontal and Vertical Offset:	Horizontal offset varies per lens, up to 80% Vertical Offset: Varies per lens, up to 130%	Horizontal offset varies per lens, up to 80% Vertical offset: varies per lens, up to 130%
Light Output:	CSMS* Specifications: Home Theater Calibration: 1706-2938 ANSI Lumens; 31.5-56.2 Foot-Lamberts (fL); Up to 3000 ANSI Lumens (All light output values are variable depending on lamp wattage output adjustment setting).	CSMS* Specifications: Home Theater Calibration: 3488-5385 ANSI Lumens; 65.4-101.3 Foot-Lamberts (fL); Up to 6000 ANSI lumens (All light output values are variable depending on lamp wattage output adjustment setting).
Contrast Ratio:	CSMS* Contrast Ratio: 131.1 - 142:1; 1000:1 ANSI	CSMS* Contrast Ratio: 134:1–140:1; 1000:1 ANSI
Lamp:	700W Xenon lamp, adjustable from 450W to 700W	1.2kW Xenon lamp, adjustable from 800W to 1.2kW
Lamp Life:	1000 hours @ 6500° Kelvin	1000 hours @ 6500° Kelvin
Inputs:	(1) RGB/Component, (1) DB 15-pin	(1) RGB/Component, (1) DB 15-pin

Specifications

<u>Specifications:</u>	<u>VX-4c</u>	<u>VX-6c</u>
Memories:	100 Discrete memories	100 discrete memories
12V Output:	See Controller for Specifications	See Controller for Specifications
Power Requirements:	100-240V AC, 50/60 Hz, 1150W	220-240V AC, 50/60 Hz, 1700W
Operating Environment:	41°–95° F, (5°–35° C), 20%–85% Humidity (non-condensing)	41°–95° F, (5°–35° C), 20%–85% Humidity (non-condensing)
Dimensions (w/out feet):	Width: 28 9/10 in. (734.00 mm) Depth: 31 3/5 in. (802.60 mm) Height: 13.0 in. (330.20 mm) Weight: 175 lbs. (79.4 kg) (without lens)	Width: 28 9/10 in. (734.00 mm) Depth: 31 3/5 in. (802.60 mm) Height: 13.0 in. (330.20 mm) Weight: 181 lbs. (82.3 kg) (without lens)
Regulatory Approvals:	Complies with FCC, CE, C-Tick	Complies with FCC, CE, C-Tick
Limited Warranty:	<u>Projector:</u> (2) Two years parts and labor from the date of delivery to the end user. <u>Lamp Warranty:</u> 1000 hours or (6) six months, which ever comes first.	<u>Projector:</u> (2) Two years parts and labor from the date of delivery to the end user. <u>Lamp Warranty:</u> 1000 hours or (6) six months, which ever comes first.

* ANSI Lumen Specification:

This is the typical projector luminosity (brightness) specification found in most sales literature. This measurement is included in RUNCO literature to allow for direct comparison with other manufacturer's projectors. These measurements can be taken at 9,000° to 13,000° Kelvin to get expected performance data when the projector is used in professional, commercial, and industrial displays.

CSMS Home Theater Calibration ANSI Lumen Specification:

These measurements are taken from the projector as set up in a home theater environment. The projector is calibrated to ISF specifications including setting the color temperature to 6500° K, the standard for reproducing video.

CSMS Home Theater Calibration foot-Lambert (fL) Specification:

This is the unit of measurement used in commercial movie theaters to express image brightness. The Society of Motion Picture and Television Engineers (SMPTE) specifies 16 fL as the target image brightness for film-based projectors using an open gate (without film in the projector). More importantly, today SMPTE specifies 12 fL as the target image brightness in Digital Cinema theaters using DLP™ technology. The foot-Lambert is dependant on screen size, screen gain, and projector light output.

All measurements are made at RUNCO to ANSI/NAPM IT7.228-1997 specifications using the Photo Research PR-650 Spectra Colorimeter and Minolta LS-100 Luminance Meter, Video Essentials test DVD, and a Da-Lite 1.5 gain, 100-inch wide screen. The projector is calibrated to a color temperature of 6500° Kelvin and has a minimum of 150 hours of usage.

VHD Ultra Controller Manual _____

The software installed in the **VHD Ultra Controller** is protected by copyright laws and International copyright treaties, as well as other intellectual property laws and treaties.

IMPORTANT - READ CAREFULLY: This Runco License Agreement is a legal agreement between you (either an individual or a single entity) and Runco International for the Runco software product installed within the **VHD Ultra Controller**. By using the **VHD Ultra Controller**, you agree to be bound by the terms of this License Agreement. If you do not agree to the terms of this License Agreement, do not use the **VHD Ultra Controller**; you may, however, return it to your place of purchase.

© 2003, Runco International. All rights reserved.

Warnings and Safety Precautions_____

CAUTION:

To turn off main power, be sure to remove the plug from power outlet. The power outlet socket should be installed as near to the equipment as possible, and should be easily accessible.

REMARQUE:

Pour mettre l'appareil hors circuit, s'assurer de retirer la fiche de la prise d'alimentation. La prise d'alimentation doit être installée aussi proche que possible de l'appareil et doit être facile d'accès.

 WARNING 

TO PREVENT FIRE OR SHOCK HAZARDS, DO NOT EXPOSE THIS UNIT TO RAIN OR MOISTURE. ALSO DO NOT USE THIS UNIT'S POLARIZED PLUG WITH AN EXTENSION CORD RECEPTACLE OR OTHER OUTLETS, UNLESS THE PRONGS CAN BE FULLY INSERTED. REFRAIN FROM OPENING THE CABINET AS THERE ARE HIGH-VOLTAGE COMPONENTS INSIDE. REFER SERVICING TO QUALIFIED SERVICE PERSONNEL.

 AVERTISSEMENT 

POUR EVITER UN FEU OU UN RISQUE D'ELECTROCUTION NE PAS EXPOSER CET ENSEMBLE A LA PLUIE OU A L'HUMIDITE; DE MEME, NE PAS BRANCHER LA PRISE POLAIRE AVEC UNE RAL-LONGE A MOINS QUE LES DENTS DE LA PREMIERE NE S'Y INSERENT PLEINEMENT.

EVITER D'OUVRIR LE COFFRET CAR IL Y A, A L'INTERIEUR, DES COMPOSANTS SOUMIS A UNE HAUTE-TENSION; POUR LES REPARATIONS, S'ADRESSER A UN PERSONNEL QUALIFIE.

WARNING:

This equipment has been tested and found to comply with the limits for a Class B digital device, pursuant to Part 15 of the FCC Rules. These limits are designed to provide reasonable protection against harmful interference when the equipment is operated in a commercial environment. This equipment generates, uses, and can radiate radio frequency energy and, if not installed and used in accordance with the installation manual, may cause harmful interference to radio communications. Operation of this equipment in a residential area is likely to cause harmful interference, in which case, the user will be required to correct the interference at his own expense.

DOC compliance Notice

This Class B digital apparatus meets all requirements of the Canadian Interference-Causing Equipment Regulations.

DOC avis de conformation

Cet appareil numérique de la classe B respecte toutes les exigences du Règlement sur le Matériel D'interférence du Canada.

Safety Tips

Please read and follow the safety precautions listed below to ensure the equipment is free from damage, and to ensure that no injury will occur as a result of improper use.

- Do not insert any object, especially metal or liquids, into the **VHD Ultra Controller**.
- Do not place any objects containing water or any other liquid on top of the **VHD Ultra Controller**.
- Do not place the unit in direct sunlight, near heaters or in extremely dusty or humid locations
- Do not install this unit outdoors or otherwise exposed to the elements
- Do not place heavy objects on top of the unit
- If the power cord is damaged or frayed in any way, electrical shock and/or fire may result. Please do not place objects on the power cord, and keep the cord away from heat-emitting devices. Should the power cord become damaged in any way, please contact your Runco dealer for a replacement cord.
- Do not remove the cover of the unit for any reason. If any problems arise with the unit, please contact a Runco dealer or Runco International for service. Removing the cover will void the warranty.

INTRODUCTION

General Description

Congratulations on your purchase of the **VHD Ultra Controller** video processor with Vivix™ technology! This processor is designed to maximize the image quality of your fixed-pixel display or rear-screen television while adding an extra level of flexibility to your system. The **VHD Ultra Controller's** Vivix™ processing techniques enable this processor to be used most efficiently with fixed-pixel displays, and will provide the most stunning image that your display can possibly deliver.

Vivix™ is a proprietary technique developed by Runco engineers to match the output resolution of the processor precisely to the display it will be used with. This precision processing technique resolves all the problems that conventional video processors have with fixed-pixel displays, which include pixel-tracking artifacts (jagged lines, moiré, jerky motion, etc.), too much overscan (significant loss of image) and even improper and disproportionate aspect ratios. The results of Vivix™ technology is an image that nearly rivals that of a CRT, while providing three geometrically-correct aspect ratios on a 16:9 or a 4:3 screen.

Features and Benefits

The **VHD Ultra Controller** have many great features and benefits that make it a flexible, high-quality processor. Its many benefits include:

- Vivix™ Technology, which maximizes image quality and flexibility of fixed-pixel displays.
- An adaptive 2-dimensional comb filter that greatly reduces artifacts when using a composite video signal as an input.
- A Luma edge enhancement circuit makes the edges of objects appear sharper without the ringing and noise increase associated with traditional sharpness circuits
- A Chroma edge enhancement circuit is included to compensate for lower chroma resolution found in composite and S-video.
- Inverse Telecine (3:2 pulldown) detection and processing allows the scaler to almost completely eliminate interlace artifacts associated with other scalers
- The controller can correctly scale anamorphic, letterbox and 4:3 formats to fit on a wide aspect-ratio screen, and scale anamorphic formats on a 4:3 screen
- A pass-through connector is supplied for routing HDTV or computer graphics directly to the display.
- An RS-232 input is provided for easy integration into the automated home theater environment
- A TBC (Time Base Corrector) circuit is provided for unstable sources such as VCR's.
- 12V outputs are provided for drop screens and screen masking.
- A simple 7-button remote controls all aspects of operation. One button source selection and aspect ratio control is also provided via the remote control.

FRONT AND REAR PANEL DESCRIPTIONS

Front Panel

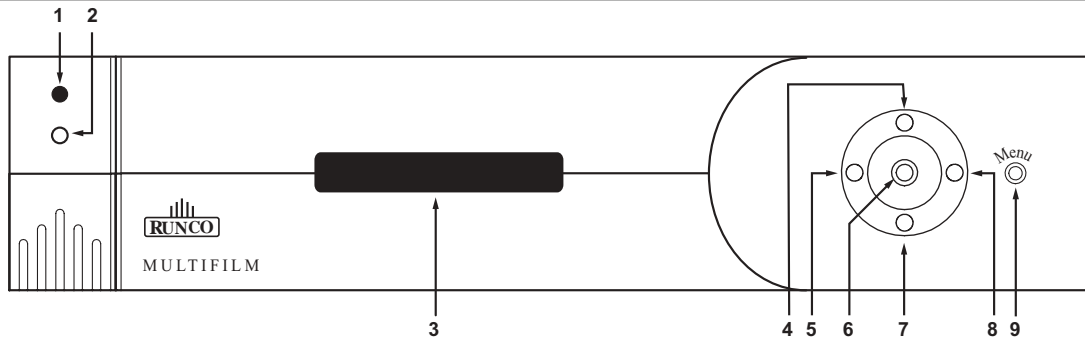

1. IR RECEIVER

Receives the IR commands from the remote control.

2. POWER BUTTON

Toggles the power on and off. For a discreet on or off command, you can use the direct access buttons on the remote control. **NOTE:** When the main AC power switch is first turned ON, the processor will go through an initiation cycle for approximately 15 seconds. The processor cannot be turned on or operated until the initialization is complete

3. LED DISPLAY

Indicates the model number, current source, resolution and aspect ratio.

4. UP BUTTON

When no menus are present on-screen, the UP button will toggle you through aspect ratios in the following order:

Letterbox → Standard (4:3) → Anamorphic

When the menu is on-screen, the UP button will move the cursor up within the menu.

When an adjustment item has been selected (i.e. brightness), the UP button will increase the value of that function.

5. LEFT BUTTON

When no menu is present on-screen, the LEFT button will toggle you through the four different sources, in the order of:

Pass-through → Component → S-Video → Composite

6. ENTER BUTTON

When an item is highlighted on the On-Screen Display, the ENTER button will select the item.

7. DOWN BUTTON

When no menu is present on-screen, this button will toggle you through the different aspect ratios.

When the menu is on-screen, the down button will move the cursor down within a menu. When an adjustment function has been selected (i.e. brightness), the DOWN button will decrease the value of that function.

8. RIGHT BUTTON

When no menus are present on-screen, the RIGHT button will toggle you through the four different sources, in the order of:

Composite → S-Video → Component → Pass-through

9. MENU BUTTON

Pressing the MENU button will bring up the main menu. If no action is taken within approximately 10 seconds, the menu will time-out (disappear). Also, if you are in an adjustment mode or function, pressing MENU will bring the menu back one level.

Rear Panel

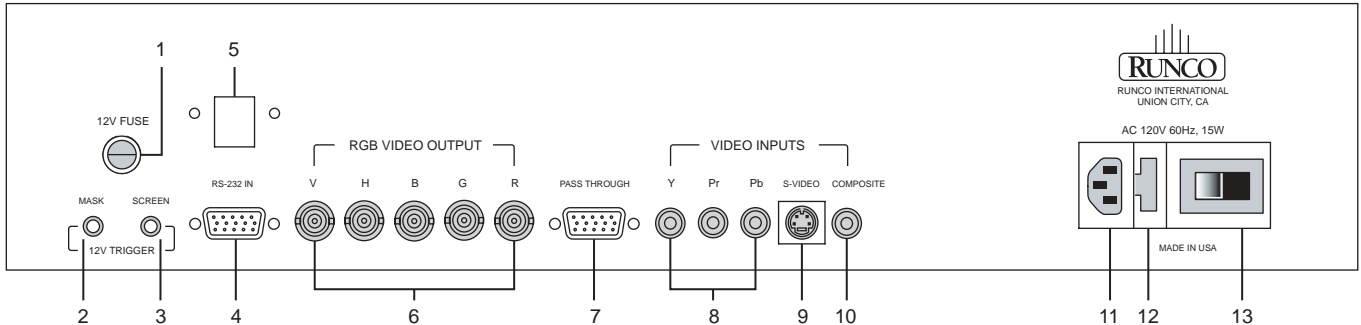

1. 12v Fuse

This fuse protects the 12v outputs from the MASK and SCREEN jacks.
(Screen Fuse: 5mm x 25mm, AGC, 0.5A 250V Fast Acting, 250V, Fast Blow)

2. Mask

This is a 12V output that is used to trigger masking on screens that have that capability.
(For use on motorized screens only).

3. Screen

This is a 12V output that is used to trigger the screen to drop.
(For use on motorized screens only).

4. RS-232 In

This is for systems using serial (RS-232) to control the **VHD Ultra Controller**.

5. Reserved for future use.

6. RGB OUTPUT

This is the main output of the **VHD Ultra Controller**. The RGB Signal goes directly to the VX-4c/VX-6c Projector. If component is used through the pass-through, then only the R (Pr), G(Y) and B(Pb) jacks will be active. Individually, the jacks are: V=vertical sync, H=horizontal sync, B=Blue, G=Green, R=Red.

7. Pass-through

Anything input to this port will by-pass the processing of the **VHD Ultra Controller** and be sent straight to the VX-4c/VX-6c Projector. This is useful for computer graphics and HDTV signals which do not require processing.

8. Component Input

This is the input for component video from sources such as DVD players.

Note: The component output from a DTV decoder or a progressive-scan DVD cannot be used with this port; it must be input to the Pass-through port.

9. S-Video Input

This is the input for S-video from sources such as Satellite receivers, S-VHS VCR's and DVD players.

10. Composite Video Input

This is the input for Composite video from sources such as Laser disc players, VCRs and other miscellaneous video sources.

11. Power Input

Plug in main power here.

12. 115 VAC Fuse

This is the main AC input fuse.(Main Fuse: 5mm x 20 mm, 500mA, 250v, Slow Blow)

13. Main Power Switch

Disconnects or applies main power to the processor.

REMOTE CONTROL DESCRIPTION

A. IR OUTPUT INDICATOR

Illuminates when a button is pressed, indicating that an IR signal is being transmitted.

B. POWER BUTTON

Toggles the power on and off. For a discreet on or off command, you can use the direct access buttons (see 'J'). **Note:** When the main AC power switch is first turned ON, the processor will go through an initiation cycle for approximately 15 seconds. The processor cannot be turned on or operated until the initialization is complete.

C. UP BUTTON

When no menus are present on-screen, the UP button will toggle you through aspect ratios in the following order:

Letterbox → Standard (4:3) → Anamorphic

When the menu is on-screen, the UP button will move the cursor up within the menu. When an adjustment item has been selected (i.e. brightness), the UP button will increase the value of that function.

D. LEFT BUTTON

When no menus are present on-screen, the LEFT button will toggle you through the four different sources in the following order:

Pass-through → Component → S-Video → Composite

E. DOWN BUTTON

When no menus are present on-screen, the DOWN button will toggle you through aspect ratios in the following order:

Anamorphic → Standard (4:3) → Letterbox

When the menu is on-screen, the DOWN button will move the cursor down within the menu. When an adjustment item has been selected (i.e. brightness), the DOWN button will decrease the value of that function.

F. RIGHT BUTTON

When no menus are present on-screen, the RIGHT button will toggle you through the four different sources in the following order:

Composite → S-Video → Component → Pass-through

G. MENU BUTTON

Pressing the MENU button will bring up the main menu. If no action is taken within approximately 10 seconds, the menu will time-out (disappear). Also, if you are in an adjustment mode or function, pressing MENU will bring the menu back one level.

H. ENTER BUTTON

When an item is highlighted on a menu, pressing ENTER will select that item.

I. PROGRAM BUTTON

If the remote control loses its 'memory' as a result of weak or dead batteries, it must be re-programmed for the **VHD Ultra Controller's** code set. To reprogram the remote, press the PROGRAM button followed by 0,1,3. **Note:** Pressing Enter after typing in the code is not necessary.

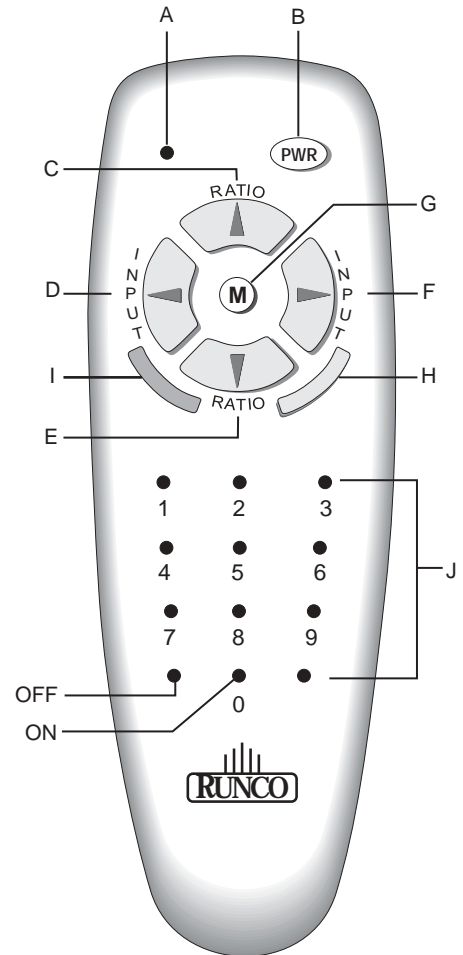

J. DIRECT ACCESS BUTTONS

These buttons will allow you to directly access an aspect ratio, source, or turn the unit on or off without having to go through any menus. These buttons are:

- 1: Selects COMPOSITE video
- 2: Selects S-video
- 3: Selects COMPONENT video
- 4: Not used
- 5: Selects PASS-THROUGH
- 6: Enables or Disables the Installation Menu (see page 6-13)
- 7: Selects the ANAMORPHIC aspect ratio
- 8: Selects the STANDARD (4:3) aspect ratio
- 9: Selects the LETTERBOX aspect ratio
- 0: Turns the processor ON.
- OFF: Also known as the button left of '0', this turns the processor OFF.

QUICK SET-UP GUIDE

Connection Examples

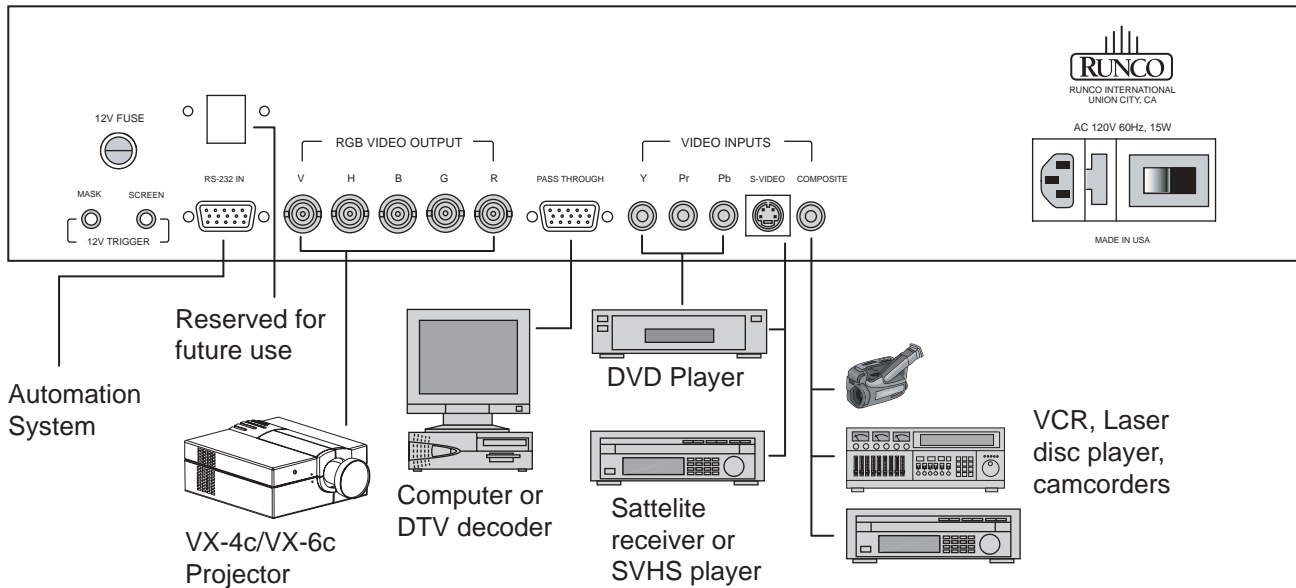

While there are many different ways to connect your source equipment to your **VHD Ultra Controller**, the examples shown above are the most common.

• COMPOSITE VIDEO INPUT:

Composite video is the most common type of signal used, but is also the lowest in picture quality. Many sources have outputs that are limited to composite video, such as some VCR's and camcorders; others such as Laser Disc players actually produce slightly better results when using composite video.

• S-VIDEO INPUT

S-video is the second-best type of signal that can be used, but is MUCH better than composite video. Using such sources as Satellite receivers, high-quality VCRs and DVD players (with no component output) will produce a MUCH cleaner and sharper signal.

COMPONENT INPUT

Component video is the best type of signal that can be used. The most common sources that use component outputs are DVD players, and it is highly recommended that component be used when possible. Component video goes one step beyond S-video in picture quality; chroma (color) information is more resolved and the overall picture appears more well-defined.

• PASS-THROUGH

This input is used to 'pass-through' any high-definition or computer signals that do not require processing. The signal by-passes the **VHD Ultra Controller's** processing and is sent directly to the display. The pass-through may be used for COMPONENT outputs from a DTV decoder, a progressive-scan DVD player or RGB outputs from a computer or other high-resolution sources.

MENU DESCRIPTION AND NAVIGATION_____

Main Menu

MAIN MENU

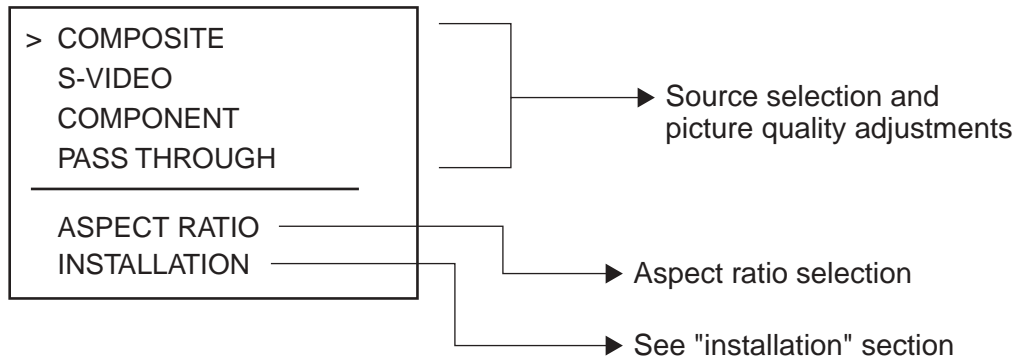

When the MENU button is pressed on either the remote control or the front panel, the main menu will appear on-screen. An example of the main menu is shown above.

The active source is indicated by an arrow to the left of the source; note that in the example above, Composite is the current source.

To select a source via the main menu, press either the up or down buttons on the remote or front panel and highlight the desired source, and press ENTER. Otherwise, you may select a source by pressing either the left or right arrow buttons (on the remote or front panel) when no menus are on-screen, or by pressing one of the direct access buttons on the remote control (recommended; see page 6-8).

If pass-through is selected, note that no on-screen menus will be displayed since the signal is simply being 'looped' directly to the output. When pass-through is the selected source, pressing MENU will automatically select the last selected input before Pass-through was selected. If you wish to choose another source, Runco recommends using the direct access buttons to select the desired source as opposed to pressing MENU.

Aspect Ratio provides selection of one of three aspect ratios: Anamorphic, Letterbox or standard 4:3. To select an aspect ratio via the main menu, press either the up and down buttons on the remote or front panel, highlight ASPECT RATIO and press ENTER. The aspect ratio menu will then appear with the three choices; highlight the desired aspect ratio with the up or down buttons and press ENTER. Otherwise, you may select an aspect ratio by pressing either the up or down arrow buttons (on the remote or front panel) when no menus are on-screen, or by pressing one of the direct access buttons on the remote control (recommended; see page 6-8).

Installation is where the image shift and blanking controls are located. A full description of this menu is on page 6-13.

NOTE: If INSTALLATION does not appear on the main menu, see page 6-13 for an explanation on how to access the Installation menu.

Picture Quality Adjustments

MAIN MENU

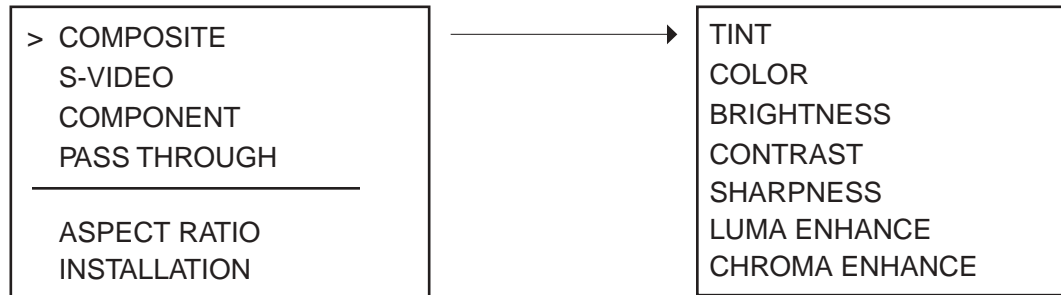

Picture quality adjustments (also known as "Front Panel Controls") are the controls that change different parameters of the image such as the amount of color, black level, etc. While these adjustments can be set to suit the needs of the user, there is a way to set these properly. This section will describe what each function does and how to adjust them properly.

To access the picture quality adjustments, press MENU, highlight the active source (indicated by the arrow) and press ENTER. The picture quality sub-menu will then appear (see above).

To make an adjustment to a particular function, highlight the function with the up or down arrow buttons and press ENTER. Once the function is on-screen (i.e. brightness), pressing the UP arrow button on the remote or front panel will increase the value of that function; pressing the DOWN arrow on the remote or front panel will decrease the value of that function.

While each of the picture quality adjustments can be set to suit the needs of the user, there is a 'proper' way to set the adjustments. For setting TINT and COLOR, please refer to the color bar test pattern below.

NOTE: Runco recommends that a BLUE FILTER be used so only the blue color bars can be seen. Blue filters are

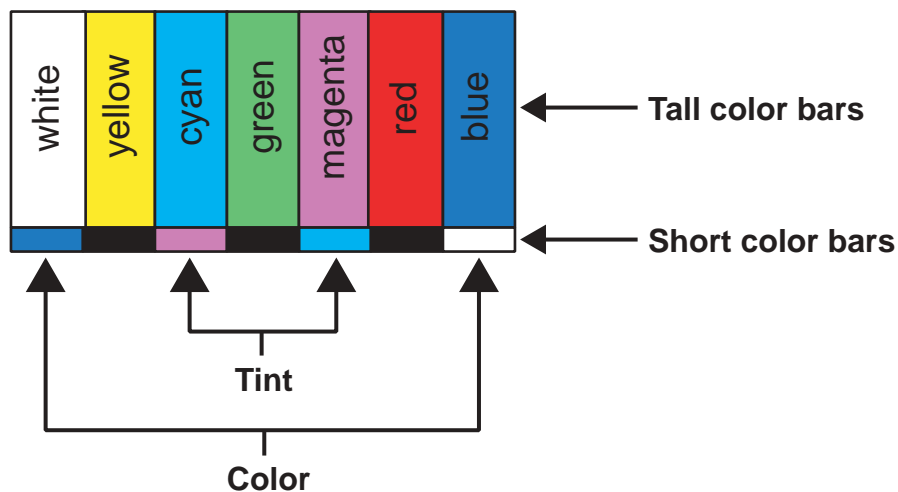

provided with the Video Essentials or AVIA test DVDs, or can be purchased from the Imaging Science Foundation (www.imaging-science.com).

TINT (also known as 'hue') is essentially the ratio of red to green in the color portion of the image. If TINT is decreased, the image will appear redder, and increasing it will cause the image to appear greener. To set TINT properly, look at the color bar pattern through a blue filter (or mute the red and green outputs). Adjust TINT until the middle two tall color bars match the middle short color bars (see color bar drawing).

COLOR (also known as 'saturation') increases or decreases the amount of color in the image. To set COLOR properly, look at the color bar pattern through a blue filter (or mute the red and green outputs). Adjust COLOR until the outer two tall color bars match the outer short color bars (see color bar drawing).

For setting **CONTRAST** and **BRIGHTNESS**, please refer to the PLUGE pattern below:

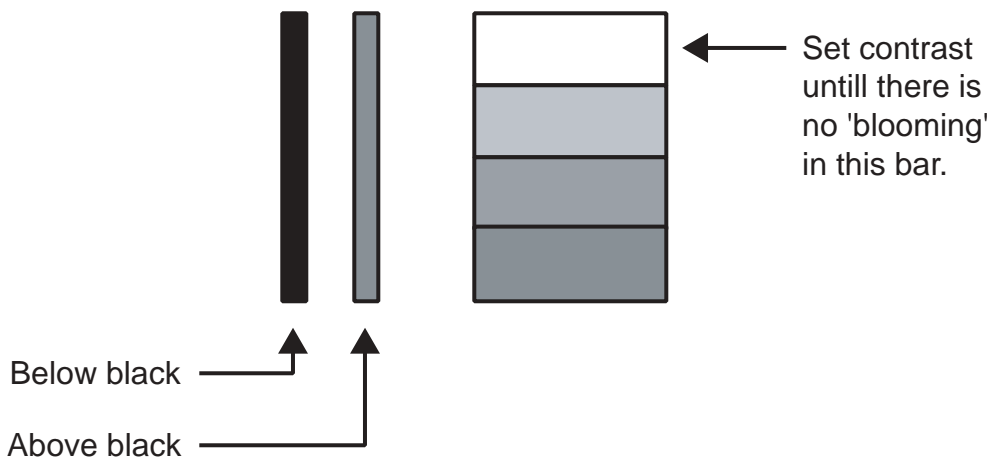

CONTRAST adjusts the white level of the image. To adjust this properly for CRT projectors, adjust **CONTRAST** until there is no blooming (or distortion) in the brightest bar in the PLUGE pattern (see above). For Fixed-pixel displays, adjust contrast until there is a distinct definition between the two brightest bars. **NOTE:** For best results, Runco recommends that **CONTRAST** be set to '0' or very close to it.

BRIGHTNESS adjusts the black level of the image. To adjust this properly, adjust **BRIGHTNESS** until the 'below black' bar JUST disappears, but the 'above black' bar is still barely visible.

NOTE: Some DVD players cannot pass the 'blacker than black' bar (they won't pass PLUGE), and that bar will never be visible. In a case like this, adjust the 'above black' bar until it is slightly brighter than the background that surrounds it.

SHARPNESS adjusts the amount of high-frequency detail in the image. This can be adjusted to the preference of the user. Keep in mind that when SHARPNESS is decreased, fine details in the image will become 'soft'; when it is increased, fine details will become sharper but will also make the picture appear 'noisy' if adjusted too high.

LUMA ENHANCE acts as an edge enhancement, especially around black to white transitions in the image. Essentially, this has the same characteristics as sharpness but affects the edges of objects far more than the rest of the image.

FREQUENCIES HIGH/LOW affect the overall range of the LUMA ENHANCE feature. For example, if using a lower-quality video source such as a VCR, the FREQUENCIES should be set to LOW. For a good quality source such as a DVD player, set FREQUENCIES to HIGH. To set FREQUENCIES, press ENTER while LUMA ENHANCE is on-screen.

CHROMA ENHANCE acts as an edge enhancement, especially around color transitions in the image. Essentially, this has the same characteristics as sharpness but affects the edges of objects far more than the rest of the image.

Installation Menu

The Installation menu is where you can adjust the type of screen (4:3 or 16:9), shift the image or set blanking.

When the **VHD Ultra Controller** is turned on for the first time, the INSTALLATION item will not appear in the main menu. To enable the INSTALLATION menu, there are two options:

- With the processor *ON* and no menus on-screen, simultaneously press the *ENTER*, *UP* and *LEFT* buttons (you don't need to hold them down). Release the three buttons and press *MENU*, ensure INSTALLATION is now on the bottom of the main menu.
- With the remote control, press button 6 (with no menus on-screen). After pressing '6', press *MENU* and ensure INSTALLATION is now on the bottom of the main menu.

After INSTALLATION has been accessed, press *MENU*, highlight INSTALLATION and press *ENTER*. This will bring up the INSTALLATION MENU, shown below:

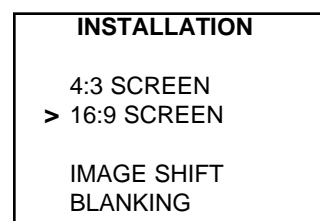

Screen Type

When you are installing the system for the first time, the first order of business is to define what type of screen will be used with this system. If a 1.78:1 (16:9) or 1.85:1 screen is used, highlight 16:9 SCREEN and press ENTER. If a standard 4:3 screen is installed, highlight 4:3 SCREEN and press enter.

The purpose of defining the screen type is to tell the processor how to create aspect ratios (see page 6-16 for a definition of aspect ratios). For example, on a 16:9 screen, the letterbox and anamorphic aspect ratios will use the entire 16:9 screen, and the 4:3 aspect ratio will be displayed in the center of the 16:9 screen (you'd have 'black bars' on the left and right sides of the image).

On the other hand, on a 4:3 screen, the 4:3 aspect ratio would fill the screen, but the letterbox and anamorphic aspect ratios would be displayed in the center of the screen vertically (there would be 'black bars' on the top on bottom of the image).

Image Shift

IMAGE SHIFT moves the entire image up, down, left or right. If the image is slightly off-center on-screen after installation, using IMAGE SHIFT can center the image on your screen or display.

While using IMAGE SHIFT will not cause any problems with your display, it is possible to use too much image shift, which could cause the image to shake or disappear. Therefore, Runco recommends that image shift be done with the display device itself whenever possible.

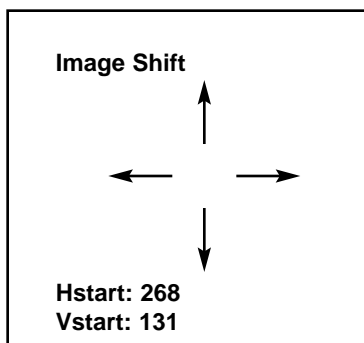

Blanking

The **BLANKING** function allows you to 'cut off' part of the image to fit the screen properly, or to eliminate anomalies on the extreme outsides (usually the top) of the image. This can be done to the top, bottom, left or right sides individually.

Blanking	
Top	131
Bottom	707
Left	241
Right	1292

To adjust **BLANKING**, highlight the desired area you wish to blank (top, bottom, left or right), and use the left and right arrows to make the adjustment.

Most CRT projectors themselves have blanking controls, and it is recommended that you use the controls on the projector as opposed to the processor, if possible. In the event that your display device does not have blanking controls, however, use the blanking controls provided in the processor.

System Reset

In the event that your **VHD Ultra Controller** appears to have a software problem, or adjustments have been made so far out of range that the image is no longer on-screen or discernable, you can reset the processor back to factory values. This sets ALL settings back to factory values, so any adjustments made previously will be lost.

To reset your VHD Ultra Controller, follow this procedure:

- Turn off the MAIN POWER switch on the back of the processor
- Hold down the DOWN ARROW button, and turn the MAIN POWER SWITCH back on. Continue holding the down arrow button until the LED on the front panel blinks, then release the down arrow button.

Once this is done, your processor has been completely reset to factory values. After resetting the unit, Composite video will be the active source.

SYSTEM RESET is not on any of the menus; it must be performed using the instructions above.

ASPECT RATIOS

FREQUENCIES HIGH/LOW affect the overall range of the CHROMA ENHANCE feature. For example, if using a lower-quality video source such as a VCR, the FREQUENCIES should be set to LOW. For a good

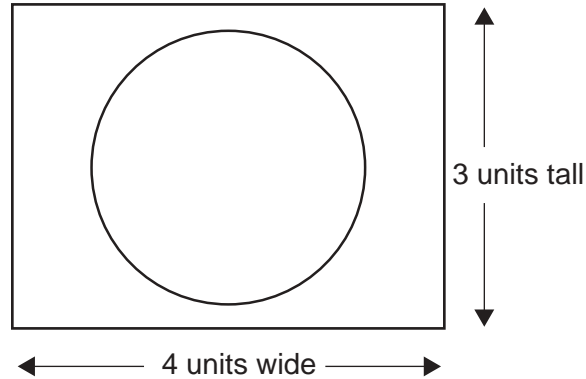

quality source such as a DVD player, set FREQUENCIES to HIGH. To set FREQUENCIES, press ENTER while CHROMA ENHANCE is on-screen.

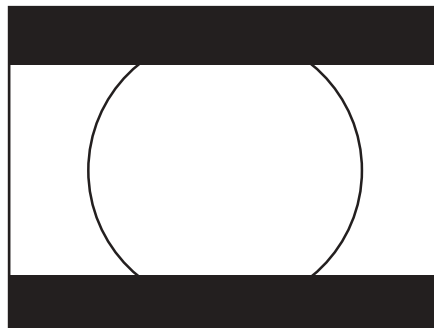

An 'aspect ratio' is simply the ratio of the width vs. the height of the screen. For example, the current aspect ratio standard is 4:3 (or 1.33:1), where the image is 4 units wide and 3 units tall.

All of our 'regular' televisions are this aspect ratio. You have probably noticed that occasionally you'll watch a movie that does not fill the screen vertically. This is because the movie was filmed in WIDESCREEN (letterbox), and the result is 'black bars' above and below the image:

Obviously, watching a movie like this does not lend itself to a truly cinematic experience! This is why Runco invented the first-ever multiple aspect-ratio projection system back in 1991, so true movie-lovers can watch actual widescreen (letterbox) movies on a WIDESCREEN!

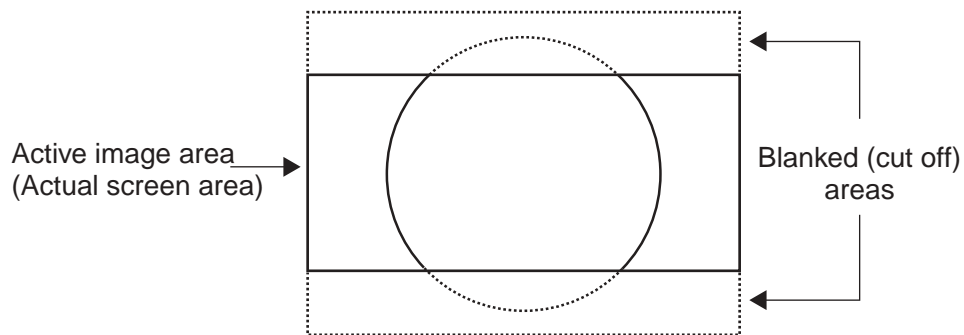

A WIDESCREEN can be a number of aspect ratios; many movies are either 1.85:1 or 2.35:1, and HDTV is always 1.78:1 (16:9). The way we create a widescreen (or LETTERBOX) aspect ratio is to take a full 4:3 image, then 'blank' (or cut off) the top and bottom so the displayed image is in a widescreen format. For movies recorded in 'letterbox', there would be no information above and below the screen anyways, so we're not losing any of the picture. However, if you were to watch standard television broadcast this way, you would lose some information (see next drawing).

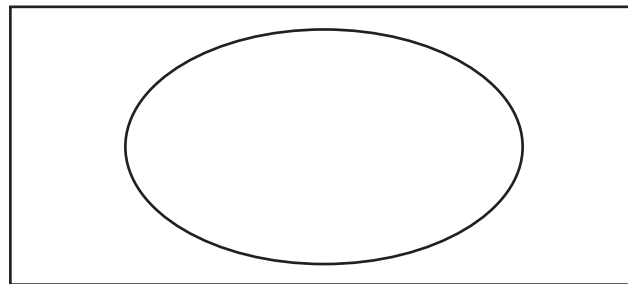

As you can see, our screen in this example is a 1.85:1 ratio. The dashed lines show the area that we 'blanked'. If you recall, watching a letterbox movie on a 4:3 screen gave us black bars; therefore with letterbox movies, we're not losing any information!

The 'other' type of widescreen is called 'ANAMORPHIC'. The image is still a widescreen format, but instead of 'blanking' the top and bottom, we simply reduce the overall height of the image:

As a result, all objects will be 'short and fat' (like the circle above), right? Well, not if you're using software that is anamorphic. Most (but not all) DVD movies have an anamorphic option.

Anamorphic material will always produce a better image when using a high quality scaler such as the **VHD Ultra Controller**. The reason is that you will actually get more lines of resolution (and ultimately more

DIMENSIONS

Front Panel

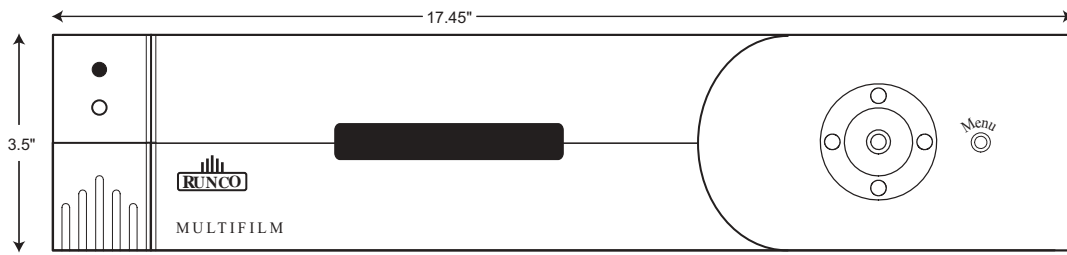

Rear Panel

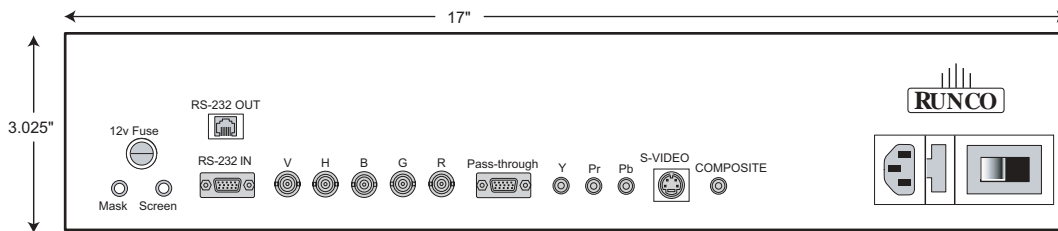

Top

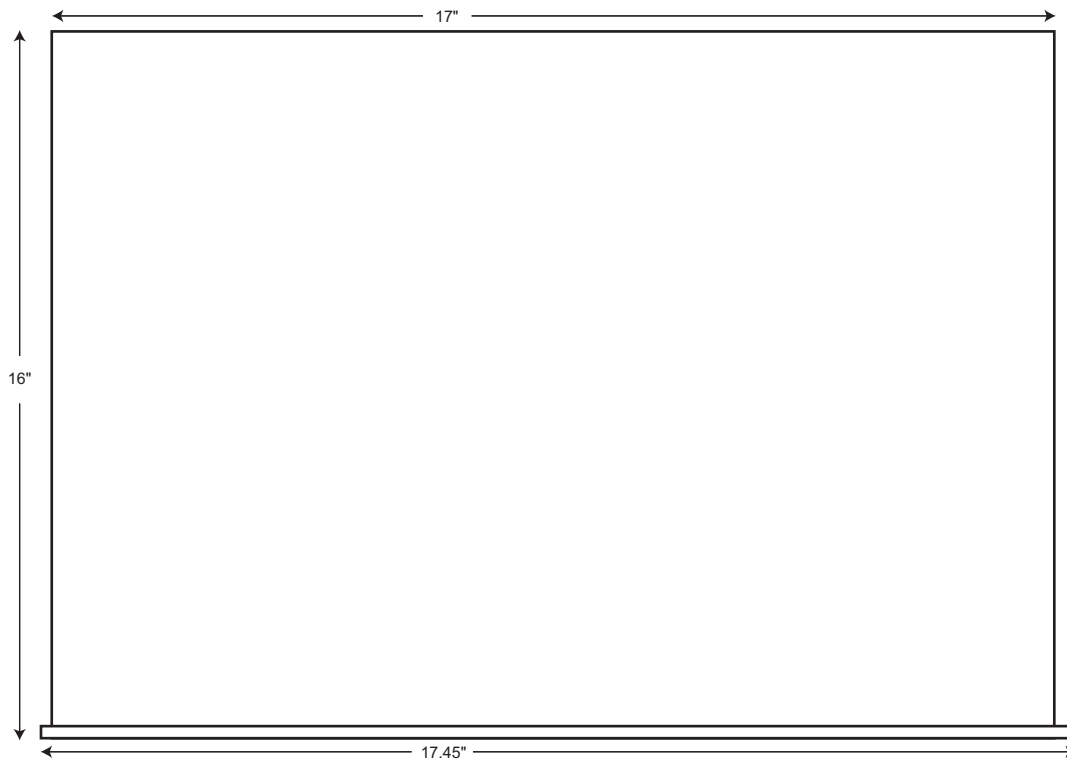

Side

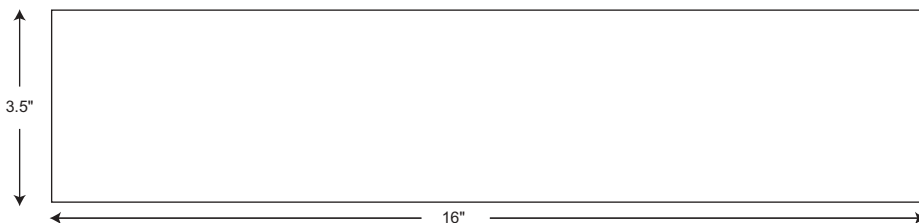

RS-232 COMMUNICATIONS

General Information

Baud rate: 9600 (fixed)

Bits: 8

No Parity

All protocol in ASCII format

RS-232 input connector pin numbers:

TxD= Pin# 2
RxD= Pin# 3
GnD= Pin# 5

Command format (single command): command value (i.e. brightness 30).

NOTE: A space (not an underscore) must be used between the command and its value.

All Commands must be followed by a carriage return.

Command string format: command,command value, command etc.

(i.e. COMPOSITE,BRIGHTNESS 30,ANAMORPHIC)

NOTE: In between commands, a comma or space can be used; a space must be used in between a command and its value. **All commands must be followed by a carriage return.**

Other notes:

- **All Commands must be followed by a carriage return.**
- For command strings, a maximum of 255 characters can be used in a single string.
- If it is necessary to input multiple commands, they should all be together in a single string. Inputting commands one at a time requires an arbitrary delay between commands while the commands are being executed. Therefore, programming requires delays and is more difficult.
- For values not automatically stored (see next paragraph), the command "!STORE" must be sent in order for the **VHD Ultra Controller** to keep the settings. Otherwise, the values will be considered temporary and will revert to their stored settings upon source change or power-up.
- The "Value stored" column refers to a command that is either automatically stored or if it must be manually stored with the "!STORE" command.
- PARAMETER min/max refers to a function's minimum and maximum value range. Inputting values above or below their range may cause unpredictable (but not fatal) results.
- After each command is entered, the Controller returns the ">" symbol as a prompt (ASCII code 0x). Use this symbol as an acknowledgement if your control system requires it.

RS-232 COMMANDS

COMMAND	PARAMETER (min/max)	Value stored?	DESCRIPTION
ON	NA	NA	Turns VHD Ultra Controller on
OFF	NA	NA	Turns VHD Ultra Controller off
DISPLAY	0/4	YES	Adjusts the brightness of the front panel display
COMPOSITE	NA	YES	Selects the Composite Video input
SVIDEO	NA	YES	Selects the S-Video Input
COMPONENT	NA	YES	Selects the Component Video input
PASSTHRU	NA	YES	Selects the Pass-through input
ANAMORPHIC	NA	YES	Selects the anamorphic aspect ratio
STANDARD	NA	YES	Selects the standard (4:3) aspect ratio
LETTERBOX	NA	YES	Selects the letterbox aspect ratio
TINT	-127/127	NO	Sets a value for tint
COLOR	-127/127	NO	Sets a value for color
AGCCOLOR	0/1	NO	0=Disable Color AGC 1=Enable Color AGC
BRIGHTNESS	-127/127	NO	Sets a value for brightness
CONTRAST	-127/127	NO	Sets a value for contrast
AGCCONTRAST	0/1	NO	0=Disable Contrast AGC 1=Enable Contrast AGC
SHARPNESS	0/255	NO	Sets a value for sharpness
CHROMAHIGH	0/127	NO	Sets a value for high-frequency chroma edge enhancement
CHROMALOW	0/127	NO	Sets a value for low-frequency chroma edge enhancement
LUMAHIGH	0/127	NO	Sets a value for high-frequency luminance edge enhancement
LUMALOW	0/127	NO	Sets a value for low-frequency luminance edge enhancement

COMMAND	PARAMETER (min/max)	Value stored?	DESCRIPTION
!STORE	NA	YES	Stores the current set of values (all values) into non-volatile memory
!RESTORE	NA	YES	Restores the stored values
!FACTORY	NA	YES	Restores all values to factory default levels
!STATUS	NA	NA	Asks the VHD Ultra Controller to provide the hardware information, current values and system status to the automation system
!RESTART	NA	NO	Restarts the VHD Ultra Controller
!ECHO	NA	NO	Enables the VHD Ultra Controller to echo back commands and values to the automation system
!NOECHO	NA	NO	Disables the VHD Ultra Controller's character echoing
!INSTALLMODEOFF	NA	NA	Disables the Installation menu (removes it from the main menu)
!INSTALLMODEON	NA	NA	Enables the Installation menu (enables it on the main menu)

VHD ULTRA SPECIFICATIONS _____

Aspect Ratios:	Anamorphic, Letterbox, 4:3 (on either 16:9 or 4:3 screens)
Input Standards:	NTSC, PAL
Outputs:	Native Resolution: 720P, 960P, 1024P and 1024P Anamorphic HD Pass-Through: Up to 1080P
Inputs:	(1) Composite, (1) S-Video, (1) Component, (1) Pass-through
Control Options:	Infrared (with discrete on/off, aspect ratio and source selection), RS-232 and Front Panel
Screen Trigger/ Masking Outputs:	(2) 12V DC, 1/8A
Bandwidth:	Video Inputs: 5.5 Mhz, PAss-Through: 100 Mhz
Power Requirements:	100-240V AC (auto sensing), 50/60 Hz, 15W
Operating Environment:	41°-95°F (5°-35° C), 0-90% Humidity, (non-condensing)
Dimensions: (w/out feet)	Width: 17 1/2 in. (444.50 mm) Depth: 16 in. (406.40 mm) Height: 3 1/2 in. (88.90 mm) Weight: 16 lbs. (7.3 kg)
Included Accessories:	Rack mounting brackets
Regulatory Approvals:	Complies with FCC Class 'B', CE, C-tick
Limited Warranty:	(2) Two years parts and labor from the date of delivery to the end user.

Glossary

This appendix defines the specific terms used in this manual as they apply to this projector. Also included are other general terms commonly used in the projection industry.

- Active Line Time** ▶▶ The time, inside one horizontal scan line, during which video is generated.
- Ambient Light Rejection** ▶▶ The ability of a screen to reflect ambient light in a direction away from the "line of best viewing". Curved screens usually have good ambient light rejection. Flat screens usually have less ambient light rejection.
- Analog Video** ▶▶ The video output of most computers and video tape machines. Analog video can generate a large number of colors.
- Aspect Ratio** ▶▶ The ratio of the width of an image to its height, such as the 4:3 aspect ratio common in video output.
- Auto Source** ▶▶ The ability of the projector to automatically recognize and synchronize to the horizontal and vertical scan frequencies of an input signal for proper display.
- Bandwidth** ▶▶ The frequency range of the projector's video amplifier.
- Baud Rate** ▶▶ The speed at which serial communications travel from their origin. In this projector, the RS-232 or RS-422 default baud rate of 38400 can be changed to match a controlling device.
- Blanking Time** ▶▶ The time inside one scan line during which video is not generated. The blanking time of the input signal must be equal to or greater than the retrace time of the projector.
- Brightness** ▶▶ In projection, brightness usually describes the amount of light emitted from a surface such as a screen. It is measured in foot-lamberts or candelas per square meter.
- Candela or Candle** ▶▶ Unit of measure for measuring intensity of light.
- Channel** ▶▶ A collection of measurements stored by the projector for a given input source, including frequencies, pulse width, polarity, syncs, channel number and location, user-adjustable display settings, etc. Use channels to switch between a variety of setups quickly, automatically recalling previously defined display parameters.
- Channel List** ▶▶ A list/menu of previously-defined channels available in projector memory.
- Channel Number** ▶▶ A number that uniquely identifies a specific channel retained in projector memory. The projector can retain up to 99 channels.

GLOSSARY

Checkbox ▶▶	A menu item that indicates whether an option is currently in effect (checked) or not (unchecked).
Color Shift ▶▶	A change in the color of a white field across an image (white field uniformity).
Color Temperature ▶▶	The coloration (reddish, white, bluish, greenish, etc.) of white in an image, measured using the Kelvin (degrees K) temperature scale. Higher temperatures appear bluer, while lower color temperatures appear redder.
Component Video ▶▶	See YCbCr or YPbPr.
Composite Video ▶▶	The output of video tape players and some computers, characterized by synchronization, luminance and color signals combined on one output cable.
Contrast (ratio) ▶▶	The degree of difference between the lightest and darkest areas of the image.
Convergence ▶▶	The alignment of the red, green, and blue elements of a projected image.
Curved Screen ▶▶	A projection screen which is slightly concave for improved screen gain. Curved screens usually have screen gains which are greater than 1 but viewing angles much less than 180°. Curved screens are not recommended for use with this projector.
DDI ▶▶	A Direct Digital Interface signal can be supplied to the projector via an optional digital input module installed in INPUT 2. For example, you can input an SMPTE-259M signal using a Serial Digital Input Module or input an SMPTE-272M signal from a HDTV Serial Input Module.
DMD™ ▶▶	Digital Micromirror Devices™ used in this projector for processing red, green, and blue color data.
Decoder ▶▶	Located at INPUT 3 and INPUT 4, this device converts NTSC 3.58, NTSC 4.4, PAL, PAL-N, PAL-M, or SECAM to RGB video.
Detail ▶▶	The sharpness of a display from a video source.
Diffused Screen ▶▶	A type of rear-projection screen which spreads the light striking it. Screen gain is less than 1 but audience viewing angles are increased.
Display Setting ▶▶	An adjustment that affects the display of an image. Such display settings include contrast, brightness, tint, blanking, size, offsets, and others.
Flicker ▶▶	A very rapid variation in image brightness caused by a frame rate that is too slow. (See Interlace.)
Frame Rate ▶▶	The frequency at which complete images are generated. For non-interlaced signals, the frame rate is identical to the vertical frequency. For interlaced signals, the frame rate (also known as field rate) is one half of vertical frequency.
Foot-candle ▶▶	The intensity of visible light per square foot.
Foot-lambert ▶▶	The luminance (brightness) which results from one foot-candle of illumination falling on a perfectly diffuse surface.
Gain or Screen Gain ▶▶	The ability of a screen to direct incident light to an audience. A flat matte white wall has a gain of approximately 1. Screens with gain less than 1 attenuate incident light; screens with gain more than 1 direct more incident light to the audience but have a narrow viewing angle. For example: An image reflecting off a 10 gain screen appears 10 times brighter than it would if reflected off a matte white wall.

Curved screens usually have larger gain than flat screens.

- Help Screen** ▶▶ A display of help information regarding the current task or presentation.
- Horizontal Frequency** ▶▶ The frequency at which scan lines are generated, which varies amongst sources. Also called horizontal scan rate or line rate.
- Horizontal Offset** ▶▶ The difference between the center of the projected image and the center of the projector lens. For this projector, this value is expressed as the maximum percentage of the image that can be projected to one side of the lens center without degrading the image quality. Horizontal offset ranges can be affected by the type of lens in use, and whether or not the image is offset vertically at the same time.
- Hot Spot** ▶▶ A circular area of a screen where the image appears brighter than elsewhere on the screen. A hot spot appears along the line of sight and "moves" with the line of sight. High gain screens and rear screens designed for slide or movie projection usually have a hot spot.
- Input** ▶▶ A physical connection route for a source signal, described by a 2-digit number representing 1) its switcher/projector location and 2) its slot in the switcher/projector.
- Input Signal** ▶▶ Signal sent from a source device to the projector.
- Interface** ▶▶ A device, such as the Serial Digital Input Module, that accepts an input signal for display by the projector.
- Interlace** ▶▶ A method used by video tape players and some computers to double the vertical resolution without increasing the horizontal line rate. If the resulting frame/field rate is too low, the image may flicker depending on the image content.
- Keypad** ▶▶ A small push-button device for controlling most projector settings and operation. For more information, refer to 3.3, Using the Keypad.
- Keystone** ▶▶ A distortion of the image which occurs when the top and bottom borders of the image are unequal in length. Side borders both slant in or out, producing a key-stone shaped image. It is caused when the screen and lens surface are not parallel.
- Linearity** ▶▶ The reproduction of the horizontal and vertical size of characters and/or shapes over the entire screen.
- Line of Best Viewing** ▶▶ When light from a projector is incident on a screen, the light reflects from the screen such that the angle of reflection equals the angle of incidence. The Line of Best Viewing is along the line of reflection.
- Loop through** ▶▶ The method of feeding a series of high impedance inputs from a single video source with a coaxial transmission line in such a manner that the line is terminated with its characteristic impedance at the last input on the line.
- Lumen** ▶▶ The unit of measure for the amount of visible light emitted by a light source.
- Lux** ▶▶ The amount of visible light per square meter incident on a surface.
1 lux = 1 lumen/square meter = 0.093 foot-candles

GLOSSARY

- Menu** ▶▶ A list of selectable options displayed on the screen.
- NTSC Video** ▶▶ A video output format of some video tape and disk players. There are two types of NTSC (National Television Standards Committee) video: NTSC 3.58 and NTSC 4.43. NTSC 3.58 is used primarily in North America and Japan. NTSC 4.43 is less commonly used.
- Optical Screen** ▶▶ A type of rear-projection screen which re-directs light through the screen to increase image brightness in front of the screen. Screen gain is usually greater than 1 but audience viewing angles are reduced.
- PAL Video** ▶▶ PAL (Phase Alternating Line) video is a 50 Hz standard with 768 x 576 resolution. It is found on some video tape and disk players (used primarily in Europe, China and some South American and African countries).
- Pincushion** ▶▶ A distortion of the image shape characterized by concave or convex borders.
- Pixel (picture element)** ▶▶ The smallest discernible element of data from a computer-generated image.
- Pixel Phase** ▶▶ The phase of the pixel sampling clock relative to incoming data.
- Pixel Tracking** ▶▶ The frequency of the pixel sampling clock, indicated by the number of pixels per line.
- Projector-to-Screen Distance** ▶▶ The distance between the projector's front feet centers and the screen. Also called "Throw Distance".
- Protocol** ▶▶ The type of code format called "A" or "B" utilized by the remote keypad(s). The default protocol set at manufacture is Protocol "A". By using two different keypad protocols, adjacent projectors can be controlled independently with their remote IR keypads.
- Pull-down List** ▶▶ A selectable menu item that unfolds into a list of options pertaining to it.
- Rear Screen** ▶▶ A translucent panel for screen projection. Incident light travels through the incident surface of a rear screen and forms an image on the other surface.
- Resizing** ▶▶ The ability to manipulate through software commands the physical size, placement and/or aspect ratio of an image.
- Resolution (lens)** ▶▶ The maximum number of alternate white and black horizontal lines that can be distinguished on a screen when a photographic target is placed between the lens and a light source and illuminated by that source.
- Resolution (projector)** ▶▶ The maximum number of pixels that the projector can display horizontally and vertically across an image, such as 1280 x 1024.
- Retrace Time** ▶▶ (Horizontal) The minimum time required for a CRT projector to move the position of the scanning spot from the right edge to the left edge.
- Rise Time** ▶▶ The time required by the video amplifier of the projector to increase its output from 10% to 90% of the maximum value.

- RGB Video** ▶▶ The video output (analog or digital) of most computers. Analog RGB video can have 3, 4, or 5 wires - one each for red, green, and blue, and either none, one or two for sync. For three-wire RGB, the green wire usually provides sync. (See TTL Video).
- RS-232** ▶▶ A common asynchronous data transmission standard recommended by the Electronics Industries Association (EIA). Also called serial communication.
- RS-422** ▶▶ A less common asynchronous data transmission standard in which balanced differential voltage is specified. RS-422 is especially suited to long distances.
- S-Video** ▶▶ The output from certain video tape players and video equipment. S-Video separates sync and luminance from color information, typically producing a higher quality display than composite video.
- Scan Frequency** ▶▶ The horizontal or vertical frequency at which images are generated.
- Scan Line** ▶▶ One horizontal line on the display.
- SECAM** ▶▶ A video output format of some video tape and disc players (used primarily in France). SECAM (Sequential Couleur à Mémoire) signals are similar in resolution and frequency to PAL signals. The primary difference between the two standards is in the way color information is encoded.
- Slidebar** ▶▶ A slidebar is a graphical display of an adjustable setting. The numerical setting often represents a percentage but can be a specific unit such as degrees Kelvin.
- Source** ▶▶ The device, such as a computer or VCR, connected to the projector for display. A source is identified at the projector as , , , or , or as other user-defined numbers. A source may have numerous corresponding channels defined and recognized by the projector. See *Input*.
- Source Setup** ▶▶ See *Channel*.
- Spot Size** ▶▶ The diameter of the smallest dot that can be generated by a CRT projector. This projector has a fixed spot (pixel) size.
- Sync** ▶▶ This term refers to the part of the video signal that is used to stabilize the picture. Sync can occur in three forms:
- 1) "Composite sync": the horizontal and vertical components are together on one cable.
 - 2) "Sync-on-green": the sync is part of the green video.
 - 3) "Separate sync" or "H.SYNC and V.SYNC": the horizontal and vertical components of the sync are on two separate cables.
- Sync Width** ▶▶ The duration of each sync pulse generated by a computer. The sync width is part of the blanking time.
- TTL Video** ▶▶ A type of RGB video with digital characteristics.
- Terminated** ▶▶ A wire connecting a single video source to a display device, such as a projector, must be terminated by a resistance (usually 75Ω for video).

GLOSSARY

- Throw Distance** ▶▶ The distance between the front feet of the projector and the screen. Also called "Projector-to-Screen Distance". Always use the correct throw distance formula to calculate the proper throw distance ($\pm 5\%$) required for your lens.
- Tint** ▶▶ Balance of red-to-green necessary for realistic representation of NTSC signals.
- Variable Scan** ▶▶ The ability of a projector to synchronize to inputs with frequencies within a specified range.
- Vertical Frequency** ▶▶ The frequency at which images are generated. Vertical frequencies vary amongst sources. Also called vertical scan rate.
- Vertical Offset** ▶▶ The difference between the center of the projected image and the center of the projector lens. For this projector, this value is expressed as the maximum percentage of the image that can be projected above or below the lens center without degrading the image quality. Vertical offset ranges depend on the type of lens in use, and whether or not the image is offset horizontally at the same time.
- Video** ▶▶ The signal that is used by display devices (such as projectors) to generate an image. This term also refers to the output of video tape/disk players and computers.
- Video Decoder** ▶▶ An optional device that converts NTSC 3.58, NTSC 4.4, PAL, PAL-N, PAL-M or SECAM to RGB video.
- Video Standard** ▶▶ A specific type of video signal, such as NTSC, PAL, SECAM. This projector can automatically recognize and interpret the incoming standard and display accordingly.
- Viewing Angle** ▶▶ Screens do not reflect equally in all directions. Most light is reflected in a conical volume centered around the "line of best viewing". Maximum brightness is perceived if you are within the viewing cone defined by the horizontal and vertical viewing angles.
- White Balance** ▶▶ The color temperature of white used by the projector.
- White Field** ▶▶ The area of an image that is white only. For example, a full white field is an image that is white everywhere. A 10% white field is a white area (usually rectangular) that occupies 10% of the image; the remaining 90% is black.
- YCbCr** ▶▶ A high-end *digital* component video signal.
- YPbPr** ▶▶ A high-end *analog* component video signal. Sometimes called YUV, Component, or Y, R-Y, B-Y, the YPbPr signal by-passes the video decoder in this projector.
- YUV** ▶▶ See *YPbPr*.
- Zoom** ▶▶ The adjustment of image size by means of a zoom lens.

KEYPAD REFERENCE

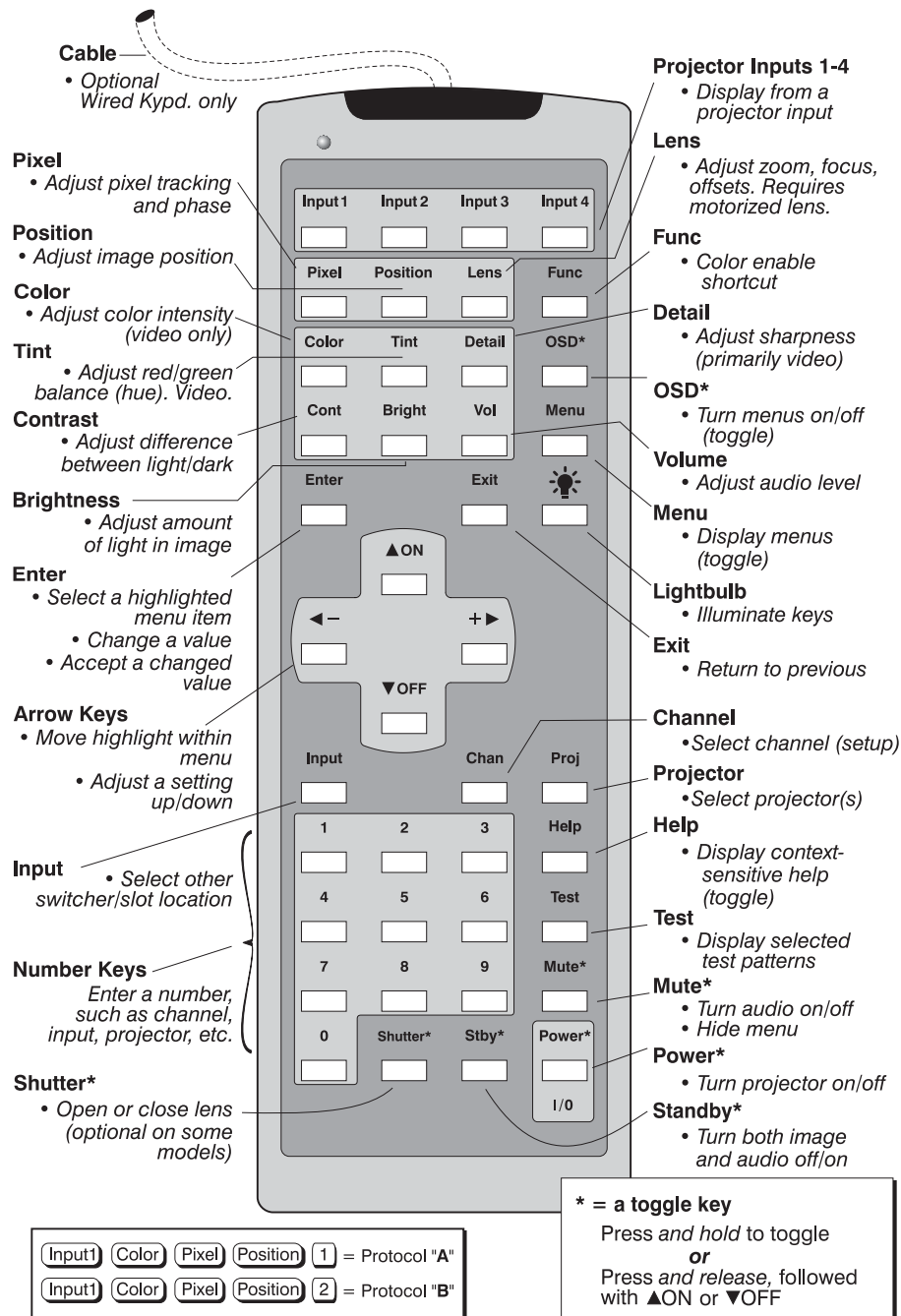
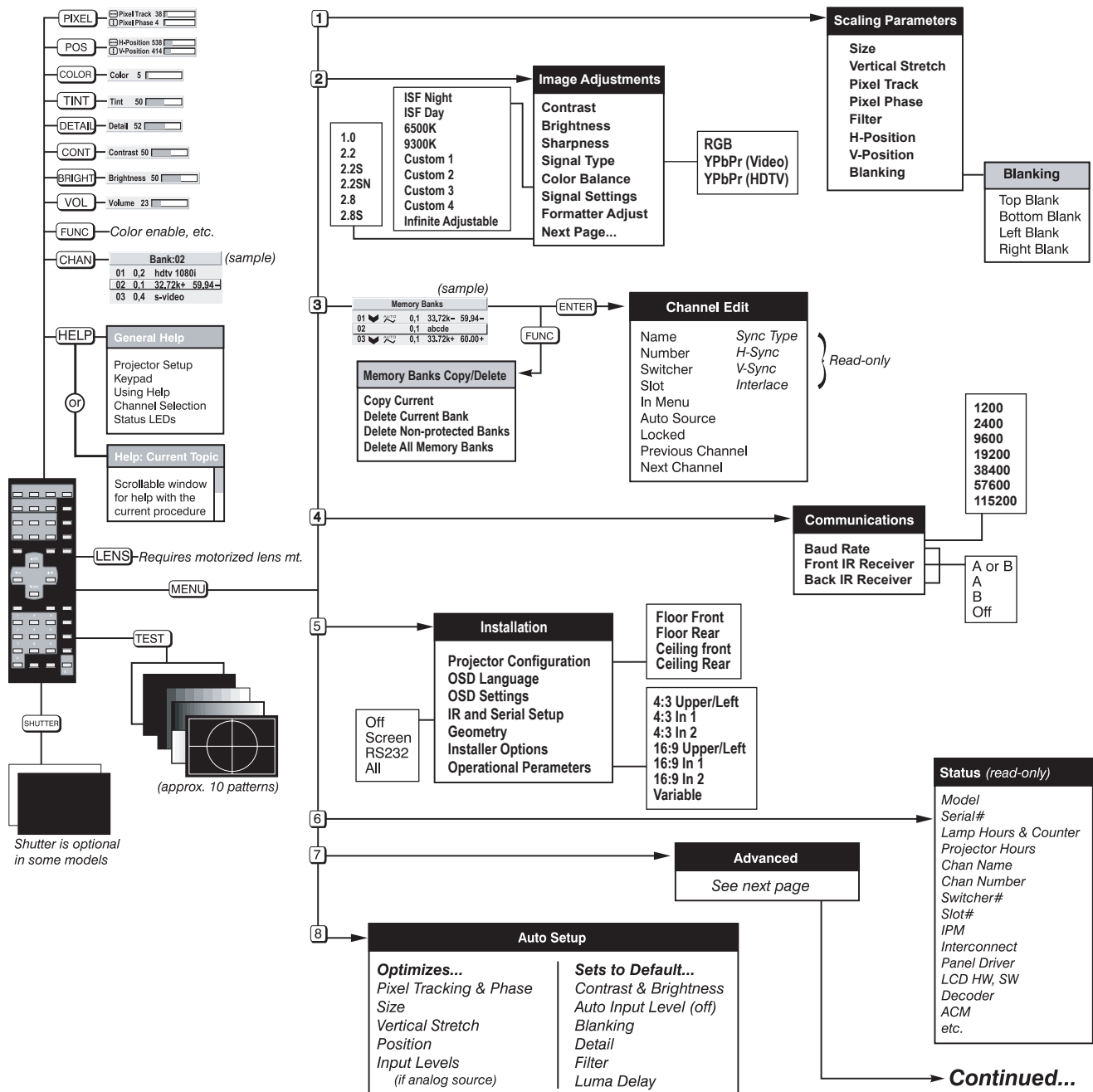
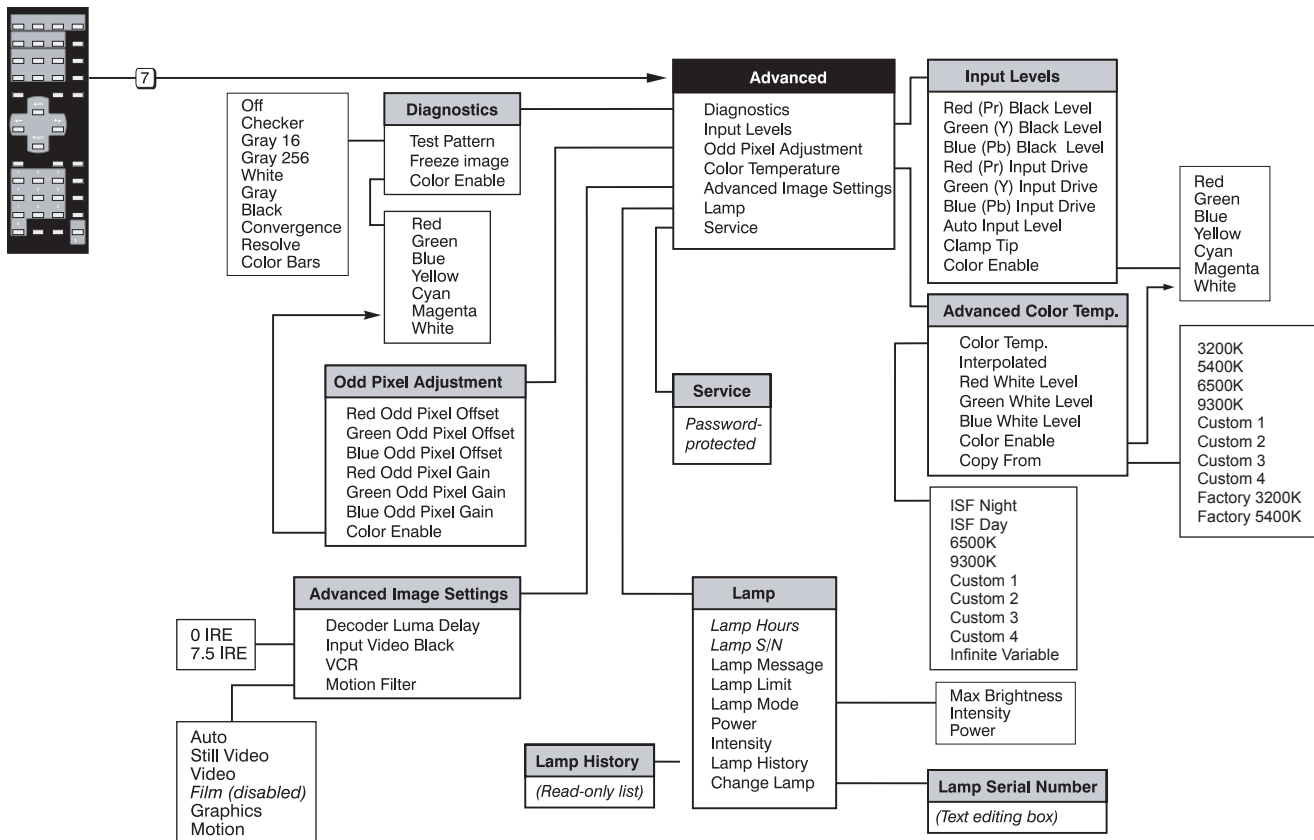

Figure B-1. Keypad

Menu Tree



Continued...



RUMA-010450 12-03



THE WORLD'S FINEST HOME THEATER PRODUCTS™